

PROFIL LED VARIO30-05 ACDE-9 2000 ANOD.



do szpachlowania



Architektoniczne



Oświetleniowe

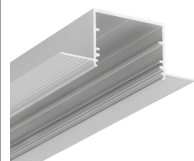

CE



Wzory przemysłowe EU



Wyprodukowane w Polsce



Kup produkt

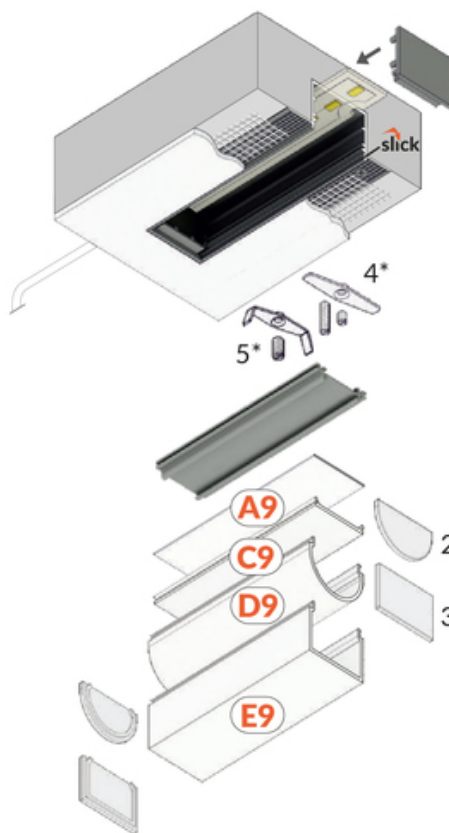
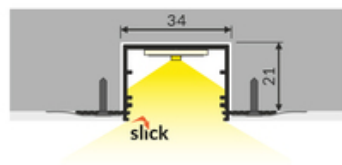
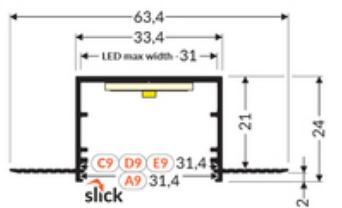

2*
end cap D9
zaslepka D9

3*
end cap E9
zaslepka E9

4*
LED clamp VARIO30
docisk LED VARIO30

5*
LED clamp VARIO30-1
docisk LED VARIO30-1



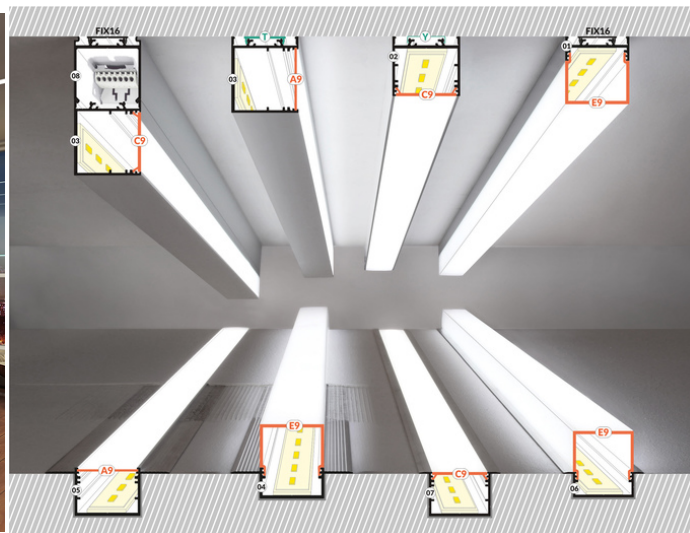

Informacje podstawowe

Indeks: V3180020
EAN: 5901597240198
Materiał: aluminium
Kolor: anodowany
Długość [mm]: 2000
Szerokość [mm]: 63.4
Wysokość [mm]: 24
Waga [kg]: 0.75
Producent: TOPMET
Kraj pochodzenia, wytworzenia: PL

Jednostka miary: szt.
Wymiary opakowania jednostkowego [mm]: 2000 x 63,4 x 24
Opakowanie zbiorcze [szt]: 20
Typ opakowania zbiorczego: pakiet
Waga produktu z opakowaniem zbiorczym [kg]: 15

DOSTĘPNE KOLORY

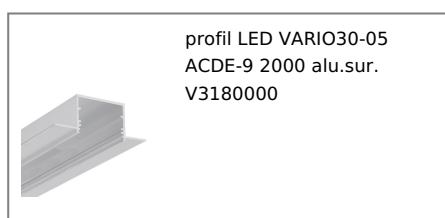

DOSTĘPNE WARIANTY

1000 mm, 2000 mm, 3000 mm, 4050 mm





Dopasowane elementy

TOPMET LIGHT KŁOSOWICZ WIŚNIEWSKI sp. z o.o.
Ostrowska 354 | 61-312 Poznań | POLAND
tel.: +48 61 872 75 00
info@topmet.pl

data wygenerowania karty pdf: 20.04.2024

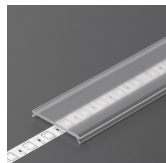
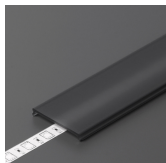
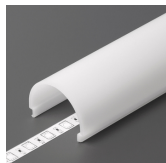

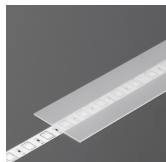
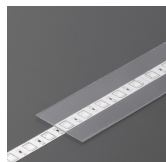
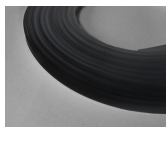
KLOSZE DO PROFILI LED

 <p>klosz C9 klik 2000 transparentny /op index: V3460016</p>	 <p>klosz C9 klik 2000 czarny /op index: V3460041</p>	 <p>klosz D9 klik 2000 mleczny /op index: V3500038</p>
 <p>klosz E9 klik 2000 mleczny /op index: V3540038</p>	 <p>klosz A9 wsuwany 2000 mleczny index: V3000238</p>	 <p>klosz A9 wsuwany 2000 szron index: V3000239</p>
 <p>klosz A9 wsuwany 2000 transparentny index: V3000216</p>	 <p>klosz C9 klik 20m rolka czarny index: V3000441S</p>	 <p>(EOL) klosz C9 klik 20m rolka mleczny index: V3000438S</p>

ZAŚLEPKI DO PROFILI LED

 <p>zaślepka D9 mleczny [20szt] index: V4980038</p>	 <p>zaślepka E9 mleczny [20szt] index: V4990038</p>	 <p>zaślepka VARIO30-05 szary [20szt] index: V4910022</p>
 <p>zaślepka VARIO30-05 srebro [20szt] index: V4910040</p>		

ŁĄCZNIKI DO PROFILI LED

 <p>łącznik VARIO30-05 60st anod. /op index: V4720020s</p>	 <p>łącznik VARIO30-05 90st anod. /op index: V4730020s</p>	 <p>łącznik VARIO30-05 90st gięty anod. /op index: V4740020s</p>
--	--	--

TOPMET LIGHT KŁOSOWICZ WIŚNIEWSKI sp. z o.o.

Ostrowska 354 | 61-312 Poznań | POLAND

tel.: +48 61 872 75 00

info@topmet.pl

data wygenerowania karty pdf: 20.04.2024



**łącznik VARIO30-05
120st anod. /op**
index: V4750020s



**łącznik VARIO30-05
135st anod. /op**
index: V4760020s



**łącznik VARIO30-05
180st /op**
index: V4650000s



**łącznik VARIO30-05
270st gięty anod. /op**
index: V4770020s