

# LED PROFILE UNI12 BCD/U 2000 ANOD.



Surface



Recessed



Furniture

	 CE  EU industrial designs  Made in Poland	 Buy product
---	---	--

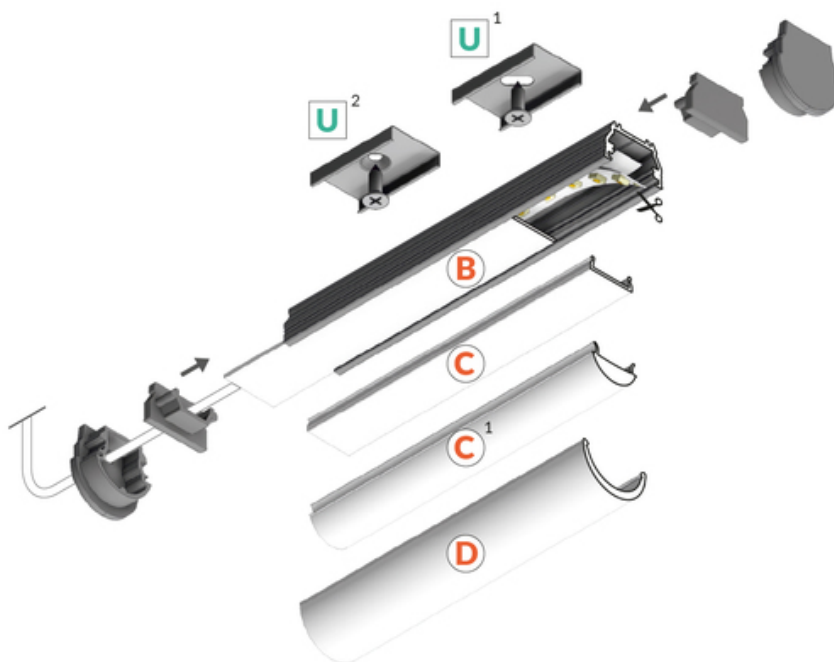
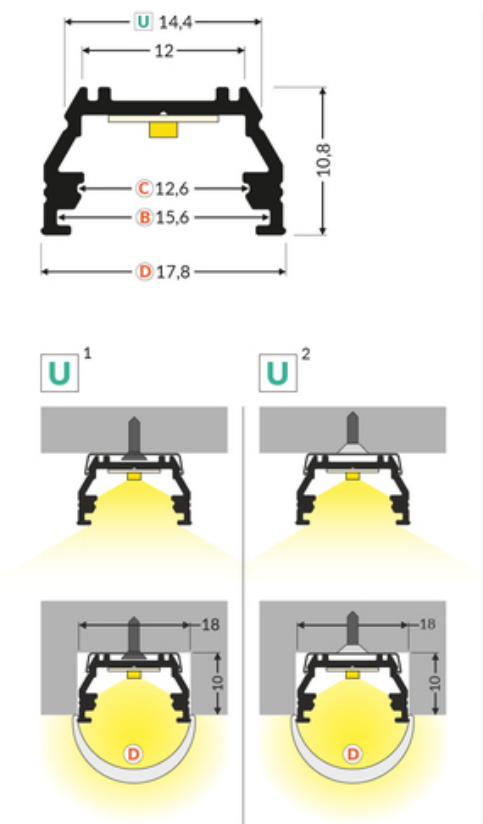

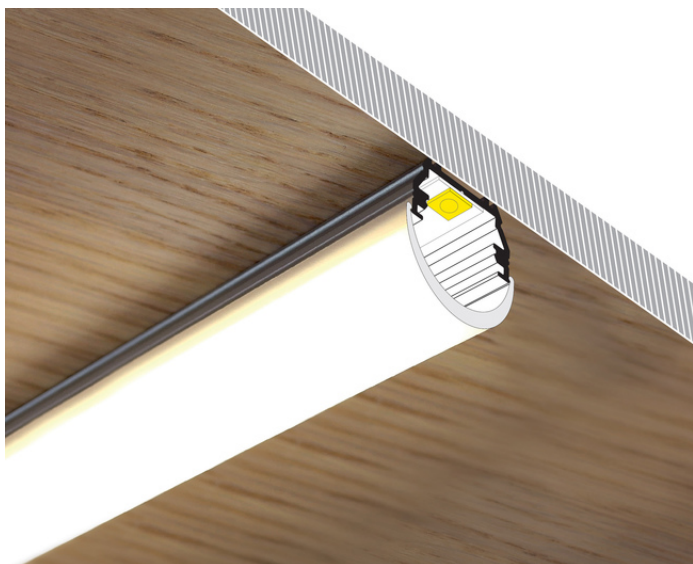



## Basic Informations

EAN: 5901597203575 Index: A1020020 Material: aluminium Color: anodized Length [mm]: 2000 Weight [kg]: 0.26 Net weight [kg]: 0.024 Country of origin: PL	Measurement unit: qty Product packaging dimensions [mm]: 2000 x 17,8 x 10,8 Bulk packing [qty]: 40 Master packaging type: Bulk Product with gross packaging weight [kg]: 10.4
--	---

## AVAILABLE COLORS

 <p>LED profile UNI12 BCD/U 2000 white painted /plastic bag A1020001</p>	 <p>LED profile UNI12 BCD/U 2000 black anod. /plastic bag A1020021</p>	 <p>LED profile UNI12 BCD/U 2000 raw alu. A1020000</p>
---	---	---

## AVAILABLE VARIANTS

1000 mm, 2000 mm, 3000 mm, 4050 mm

## Matching elements

## DIFFUSERS

**TOPMET LIGHT KŁOSOWICZ WIŚNIEWSKI sp. z o.o.**

Ostrowska 354 | 61-312 Poznań | POLAND

tel.: +48 61 872 75 00

info@topmet.pl

pdf card generation date: 23.04.2024

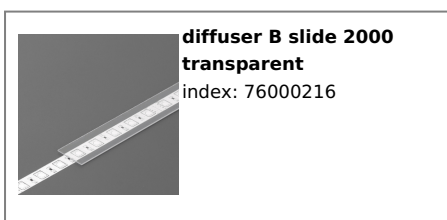
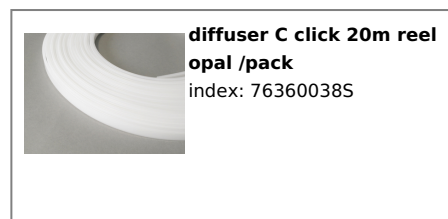
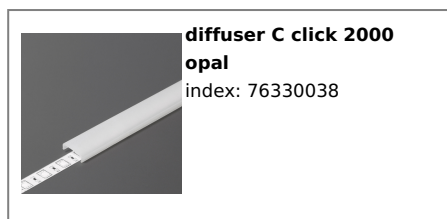

## END CAPS

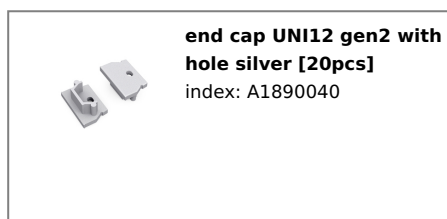
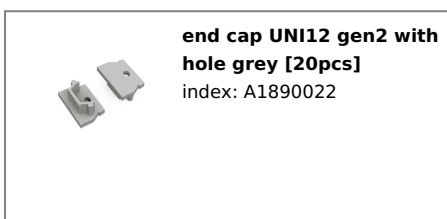
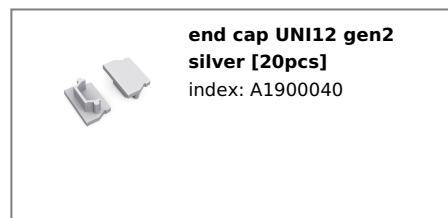
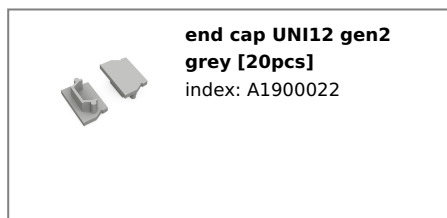
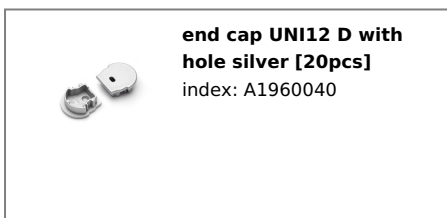
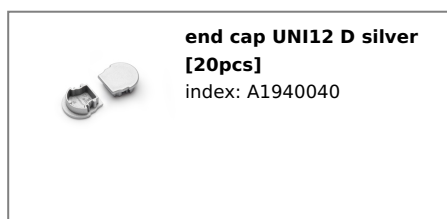
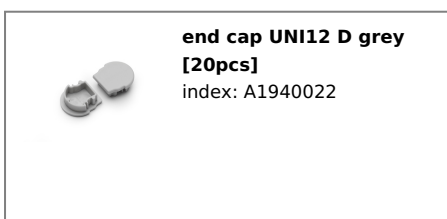

## CONNECTORS

**TOPMET LIGHT KŁOSOWICZ WIŚNIEWSKI sp. z o.o.**

Ostrowska 354 | 61-312 Poznań | POLAND

tel.: +48 61 872 75 00

info@topmet.pl

pdf card generation date: 23.04.2024



**connector UNI12 90deg  
anod. /plastic bag**  
index: A1910020

---

## MOUNTING PLATES



**mounting plate U cone  
inox [20pcs]**  
index: 76620000

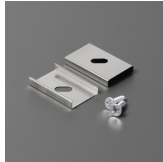

**mounting plate U inox  
[20pcs]**  
index: 76380000