

PROFIL LED SURFACE10 BC/UX 3000 ANOD.







Meblowe



max 10 mm



Nawierzchniowe

	<ul style="list-style-type: none">• ukryte mocowanie• szeroka oferta akcesoriów, 7 typów kloszy	<ul style="list-style-type: none"> Wzory przemysłowe EU CE Wyprodukowane w Polsce	 Kup produkt
---	--	--	--

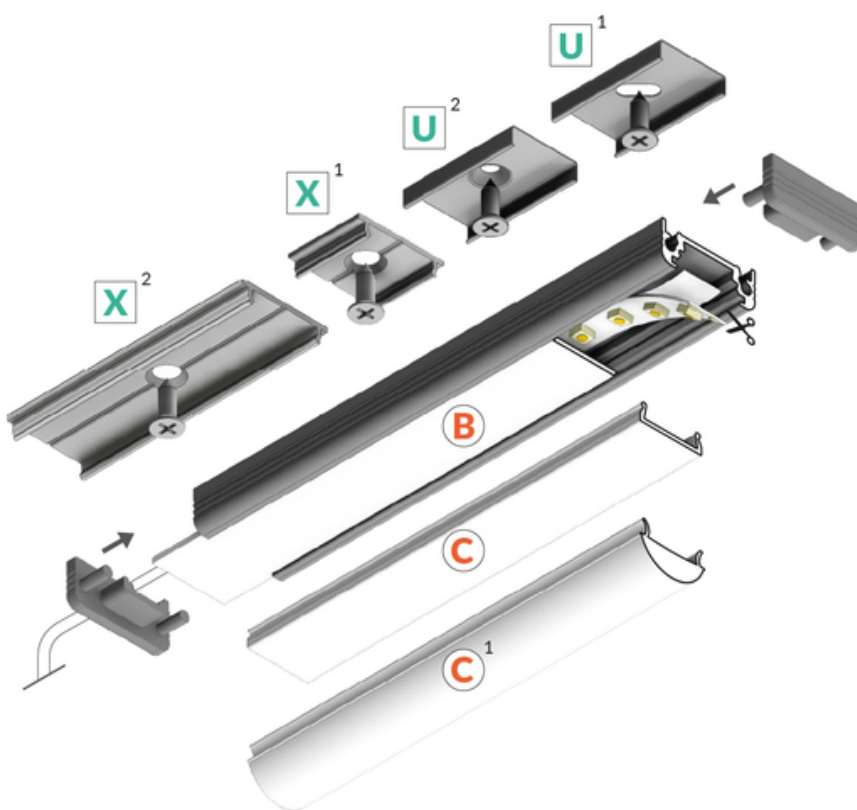
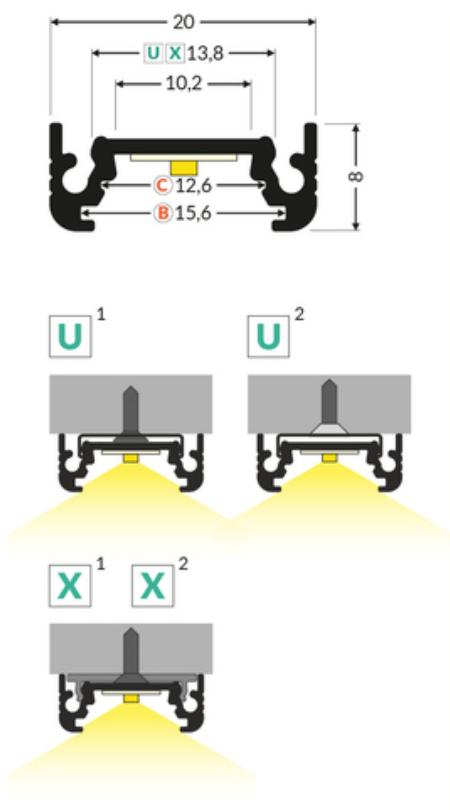

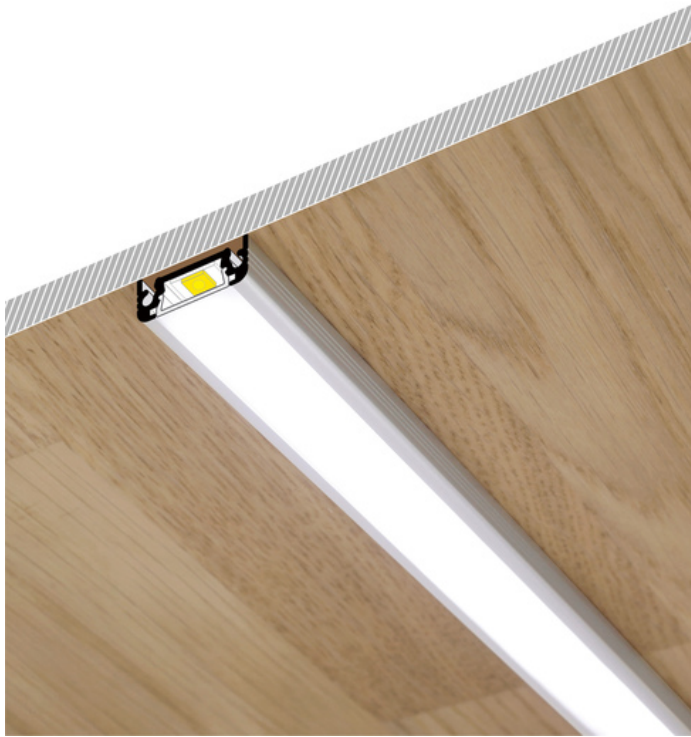

Informacje podstawowe

<p>Indeks: 77570020 EAN: 5901597239222 Materiał: aluminium Kolor: anodowany Długość [mm]: 3000 Szerokość [mm]: 20 Wysokość [mm]: 8 Waga [kg]: 0.387 Waga opakowania [kg]: 0.018 Producent: TOPMET Kraj pochodzenia, wytworzenia: PL</p>	<p>Jednostka miary: szt. Wymiary opakowania jednostkowego [mm]: 3000 x 20 x 8 Opakowanie zbiorcze [szt]: 40 Typ opakowania zbiorczego: pakiet Waga produktu z opakowaniem zbiorczym [kg]: 15.48</p>
---	---

DOSTĘPNE KOLORY

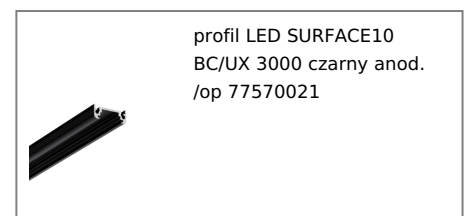
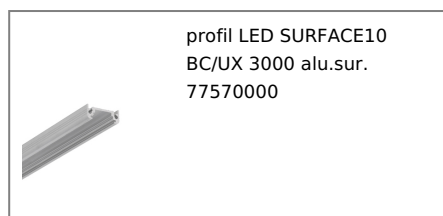
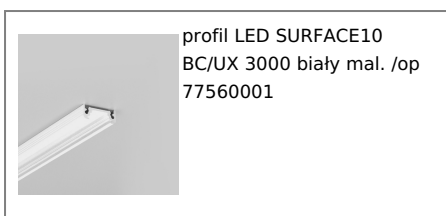

DOSTĘPNE WARIANTY

1000 mm, 2000 mm, 3000 mm, 4050 mm

Dopasowane elementy

KLOSZE DO PROFILI LED



ZAŚLEPKI DO PROFILI LED



ŁĄCZNIKI DO PROFILI LED



UCHWYTY DO PROFILI LED



**uchwyt U cone inox
[20szt]**
index: 76620000

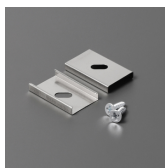

uchwyt U inox [20szt]
index: 76380000



uchwyt X [20szt]
index: 76260000