

PROFIL LED SURFACE10 BC/UX 3000 CZARNY ANOD. /OP







Nawierzchniowe



Meblowe



max 10 mm

	<ul style="list-style-type: none">• ukryte mocowanie• szeroka oferta akcesoriów, 7 typów kloszy	<p> CE</p> <p> Wzory przemysłowe EU</p> <p> Wyprodukowane w Polsce</p>	 <p>Kup produkt</p>
---	--	---	---

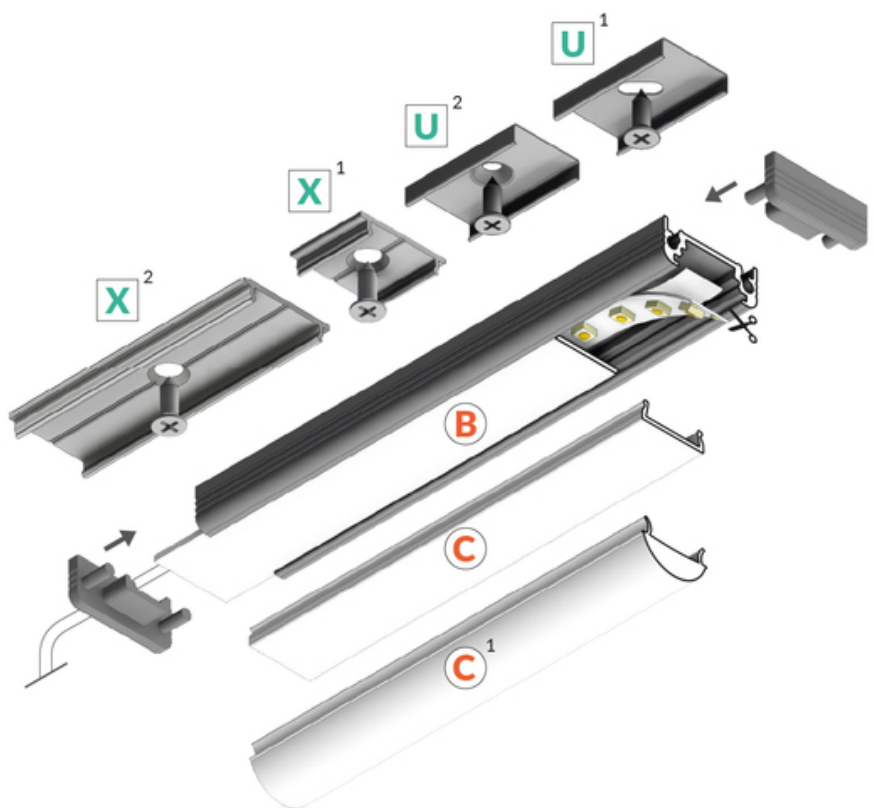
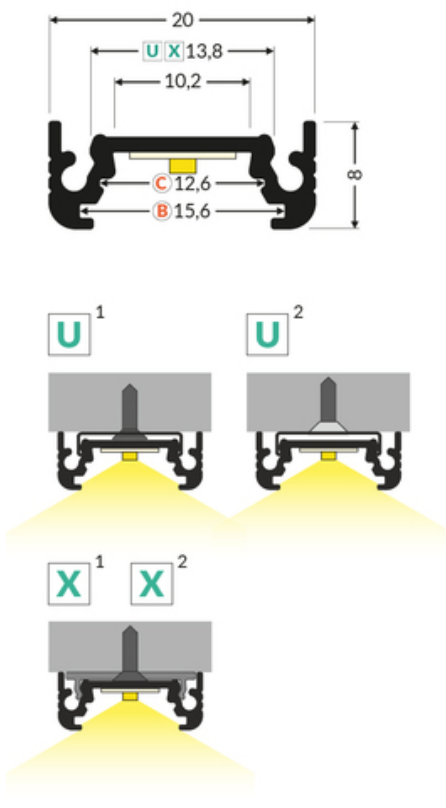

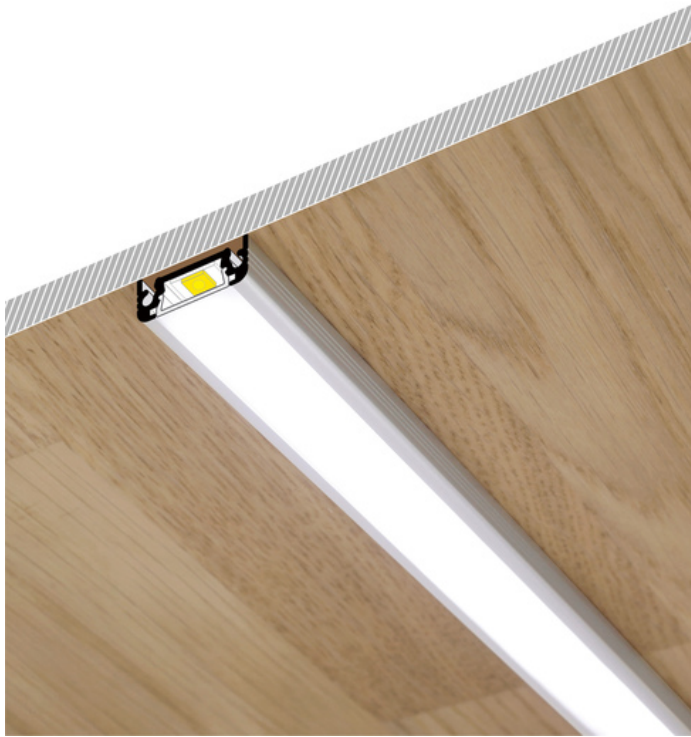



Informacje podstawowe

<p>Indeks: 77570021 EAN: 5901597252061 Materiał: aluminium Kolor: czarny anodowany Długość [mm]: 3000 Szerokość [mm]: 20 Wysokość [mm]: 8 Waga [kg]: 0.405 Waga opakowania [kg]: 0.006 Producent: TOPMET Kraj pochodzenia, wytworzenia: PL</p>	<p>Jednostka miary: szt. Typ opakowania jednostkowego: folia POF Wymiary opakowania jednostkowego [mm]: 3000 x 20 x 8 Opakowanie zbiorcze [szt]: 10 Typ opakowania zbiorczego: pakiet Waga produktu z opakowaniem zbiorczym [kg]: 4.05</p>
--	--

DOSTĘPNE KOLORY

 <p>profil LED SURFACE10 BC/UX 3000 biały mal. /op 77560001</p>	 <p>profil LED SURFACE10 BC/UX 3000 alu.sur. 77570000</p>	 <p>profil LED SURFACE10 BC/UX 3000 anod. 77570020</p>
--	--	---

DOSTĘPNE WARIANTY

1000 mm, 2000 mm, 3000 mm, 4050 mm

Dopasowane elementy

KLOSZE DO PROFILI LED



ZAŚLEPKI DO PROFILI LED



ŁĄCZNIKI DO PROFILI LED

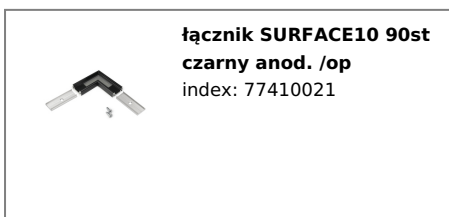

UCHWYTY DO PROFILI LED

TOPMET LIGHT KŁOSOWICZ WIŚNIEWSKI sp. z o.o.

Ostrowska 354 | 61-312 Poznań | POLAND

tel.: +48 61 872 75 00

info@topmet.pl

data wygenerowania karty pdf: 25.04.2024



uchwyt U cone inox
[20szt]

index: 76620000

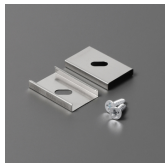

uchwyt U inox [20szt]

index: 76380000



uchwyt X [20szt]

index: 76260000