

PROFIL LED SURFACE10 BC/UX 4050 ANOD.



Meblowe



max 10 mm



Nawierzchniowe

	<ul style="list-style-type: none">• ukryte mocowanie• szeroka oferta akcesoriów, 7 typów kloszy	<ul style="list-style-type: none"> Wzory przemysłowe EU CE Wyprodukowane w Polsce	 Kup produkt
--	--	---	---------------------

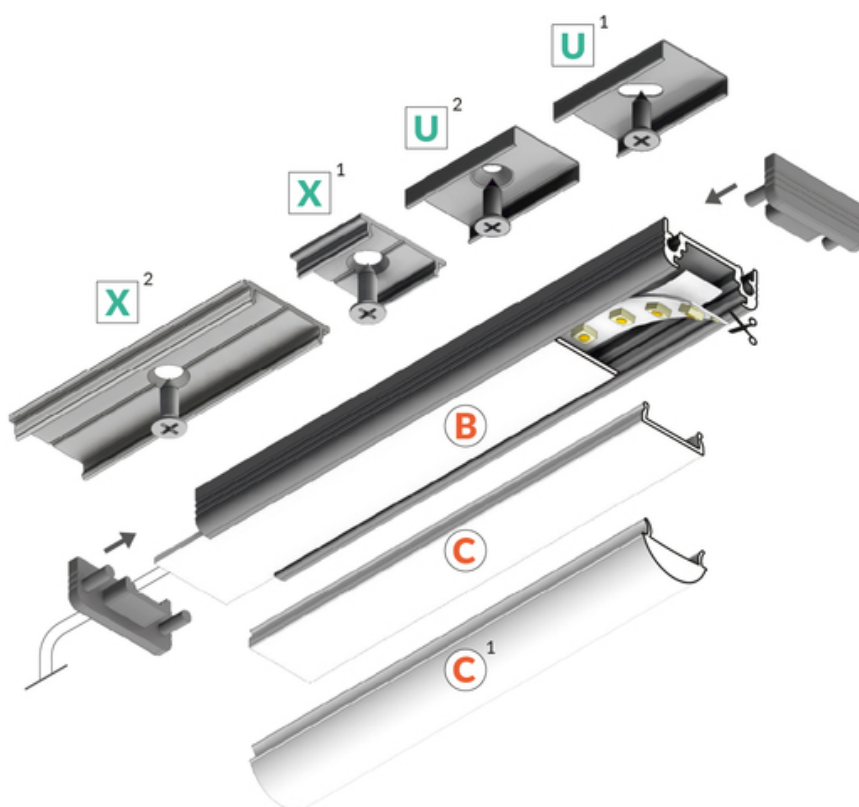
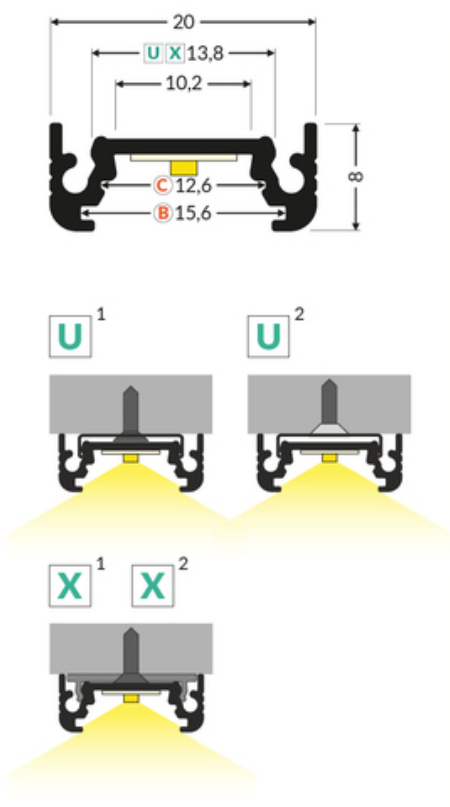

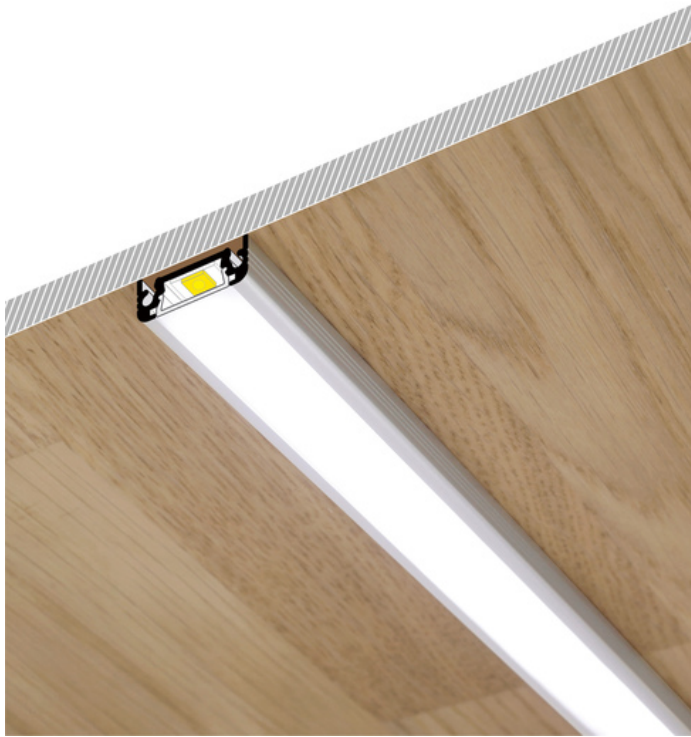

Informacje podstawowe

Indeks: 77580020 EAN: 5901597252092 Materiał: aluminium Kolor: anodowany Długość [mm]: 4050 Szerokość [mm]: 20 Wysokość [mm]: 8 Waga [kg]: 0.522 Waga opakowania [kg]: 0.012 Producent: TOPMET Kraj pochodzenia, wytworzenia: PL	Jednostka miary: szt. Wymiary opakowania jednostkowego [mm]: 4050 x 20 x 8 Opakowanie zbiorcze [szt]: 40 Typ opakowania zbiorczego: pakiet Waga produktu z opakowaniem zbiorczym [kg]: 20.88
--	--

DOSTĘPNE KOLORY

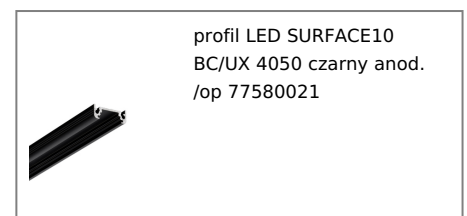
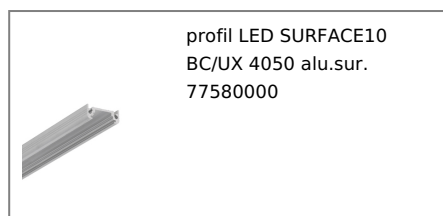
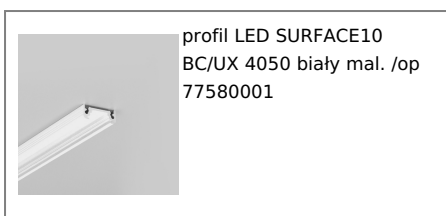

DOSTĘPNE WARIANTY

1000 mm, 2000 mm, 3000 mm, 4050 mm

Dopasowane elementy

KLOSZE DO PROFILI LED

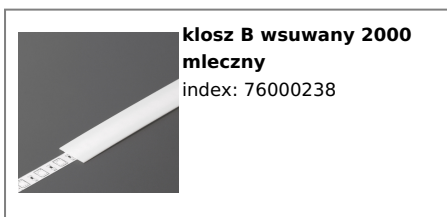

ZAŚLEPKI DO PROFILI LED

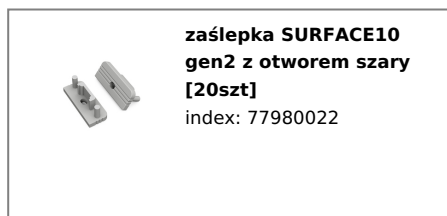

ŁĄCZNIKI DO PROFILI LED

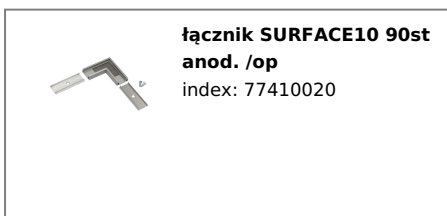

UCHWYTY DO PROFILI LED



**uchwyt U cone inox
[20szt]**
index: 76620000

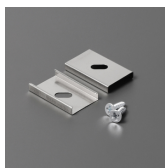

uchwyt U inox [20szt]
index: 76380000



uchwyt X [20szt]
index: 76260000