

PROFIL LED SLIM8 AC2/Z 1000 ANOD.





Meblowe



max 8 mm



Nawierzchniowe

	<ul style="list-style-type: none">• uniwersalne zastosowanie• gniazdo Slick• 2 poziomy przymocowania uchwyty (z dystansem od ściany lub bez)• malowane uchwyty	<ul style="list-style-type: none">• Wzory przemysłowe EU• CE• Wyprodukowane w Polsce	 <p>Kup produkt</p>
---	---	--	--

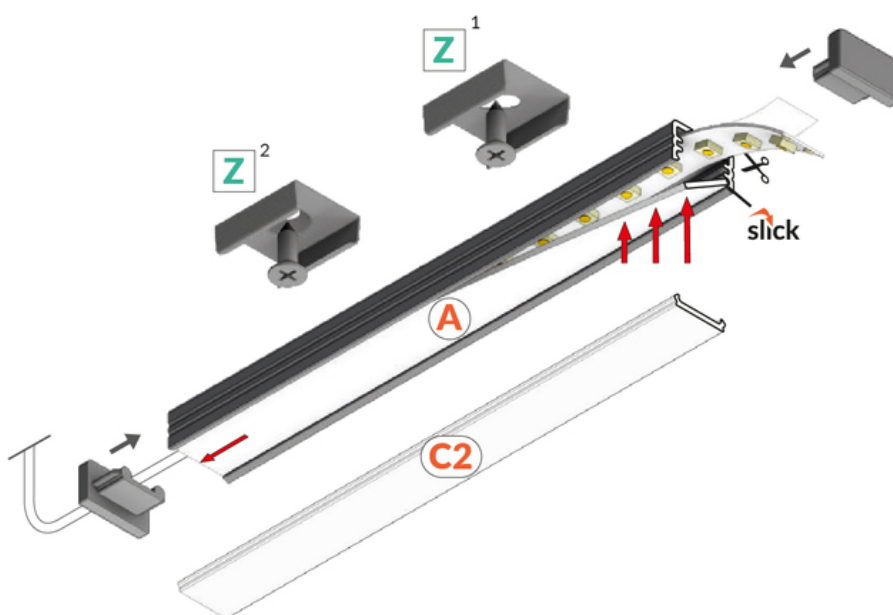
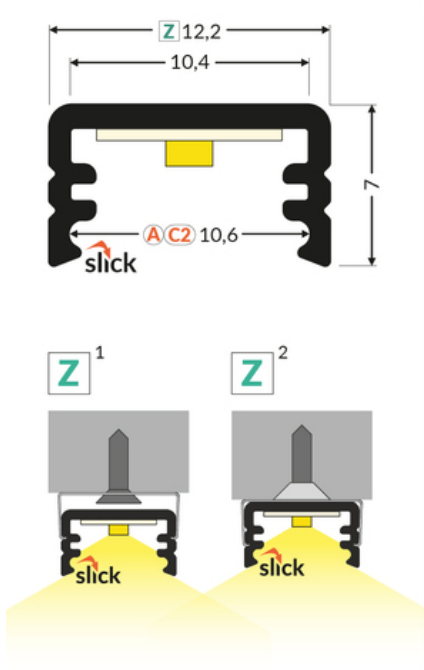

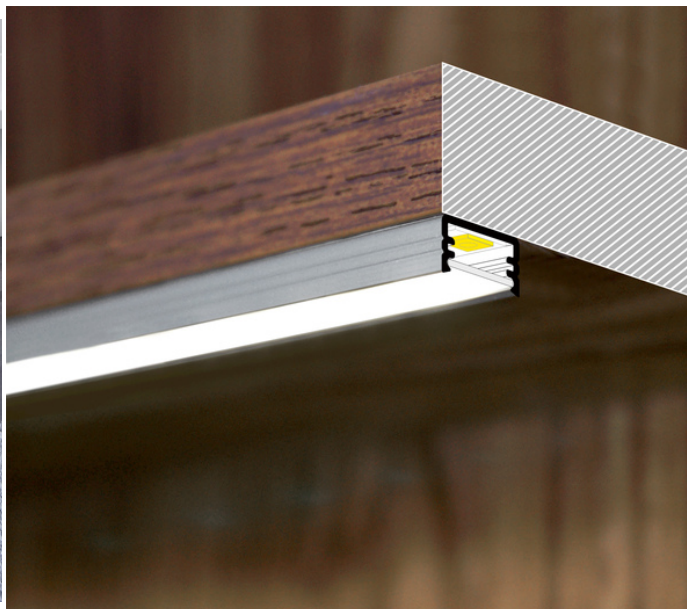

Informacje podstawowe

Indeks: 89020020
EAN: 5901597201106
Materiał: aluminium
Kolor: anodowany
Długość [mm]: 1000
Szerokość [mm]: 12.2
Wysokość [mm]: 7
Waga [kg]: 0.069
Waga opakowania [kg]: 0.018
Producent: TOPMET
Kraj pochodzenia, wytworzenia: TR

Jednostka miary: szt.
Wymiary opakowania jednostkowego [mm]: 1000 x 12,2 x 7
Opakowanie zbiorcze [szt]: 40
Typ opakowania zbiorczego: pakiet
Waga produktu z opakowaniem zbiorczym [kg]: 2.76

DOSTĘPNE KOLORY

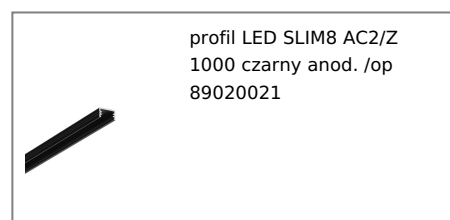
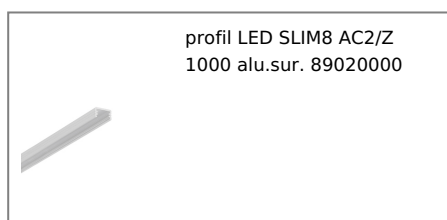

DOSTĘPNE WARIANTY

1000 mm, 2000 mm, 3000 mm, 4050 mm

Dopasowane elementy

TOPMET LIGHT KŁOSOWICZ WIŚNIEWSKI sp. z o.o.
Ostrowska 354 | 61-312 Poznań | POLAND
tel.: +48 61 872 75 00
info@topmet.pl

data wygenerowania karty pdf: 24.04.2024

KLOSZE DO PROFILI LED



ZAŚLEPKI DO PROFILI LED

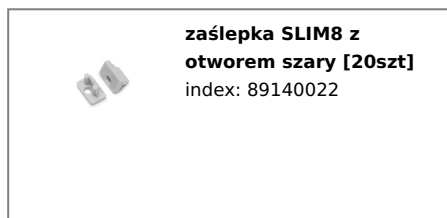

ŁĄCZNIKI DO PROFILI LED



UCHWYTY DO PROFILI LED



uchwyt Z inox [20szt]
index: 89270019



uchwyt Z cone inox [20szt]
index: 89980019