

# PROFIL LED SURFACE14 EE7F/TY 3000 BIAŁY MAL. /OP



Nawierzchniowe



Meblowe



max 14 mm



- ukryte mocowanie
- wiele akcesoriów systemowych do wyboru



CE



Wzory przemysłowe EU



Wyprodukowane w Polsce



Kup produkt

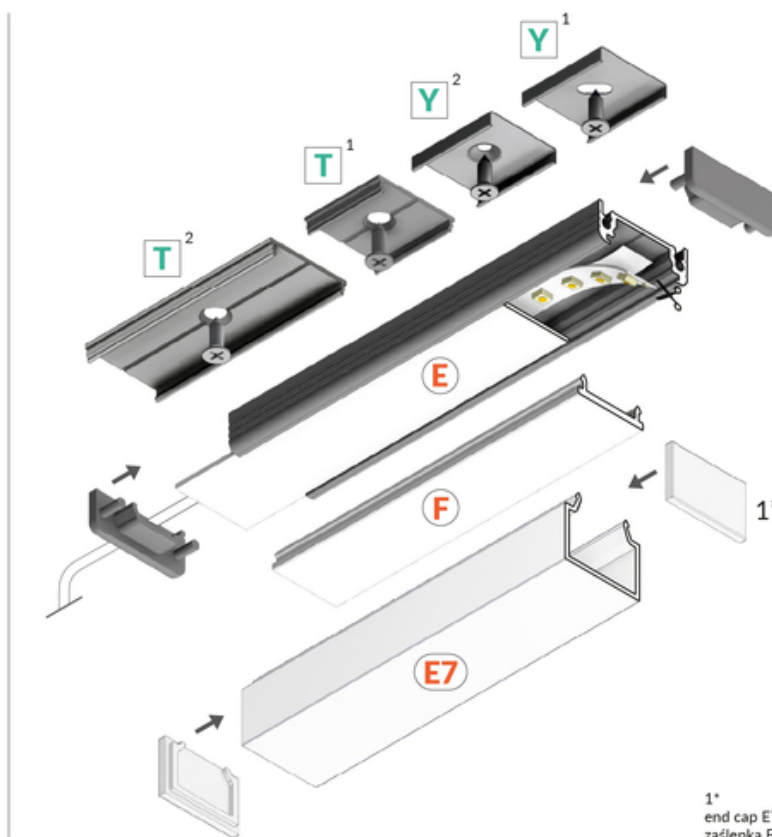
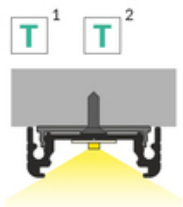
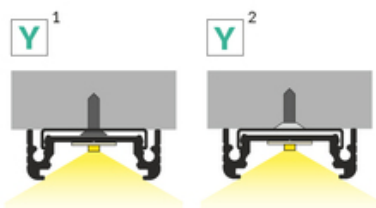
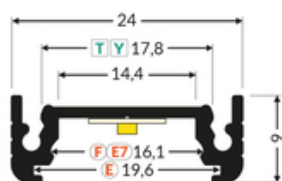

TOPMET LIGHT KŁOSOWICZ WIŚNIEWSKI sp. z o.o.

Ostrowska 354 | 61-312 Poznań | POLAND

tel.: +48 61 872 75 00

info@topmet.pl

data wygenerowania karty pdf: 20.04.2024



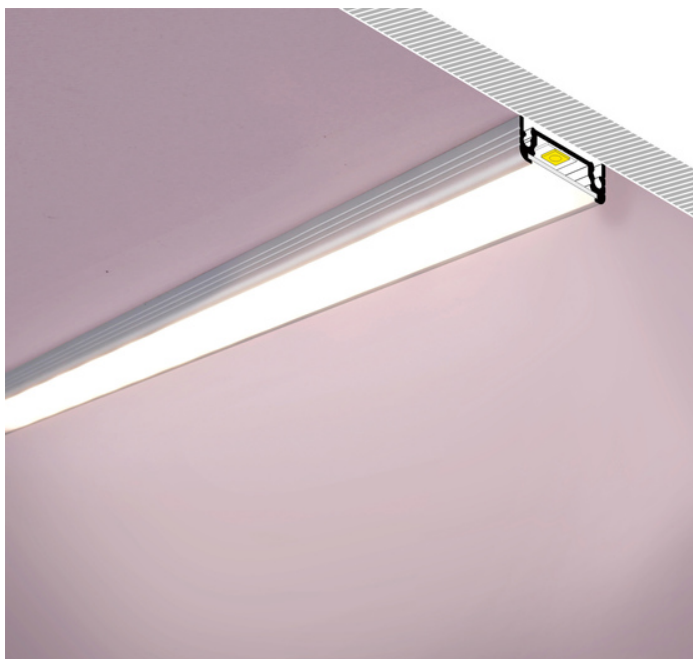

## Informacje podstawowe

Indeks: A2170001  
EAN: 5901597252177  
Materiał: aluminium  
Kolor: biały malowany  
Długość [mm]: 3000  
Szerokość [mm]: 24  
Wysokość [mm]: 9  
Waga [kg]: 0.533  
Waga opakowania [kg]: 0.024  
Producent: TOPMET  
Kraj pochodzenia, wytworzenia: PL

Jednostka miary: szt.  
Typ opakowania jednostkowego: folia POF  
Wymiary opakowania jednostkowego [mm]: 3000 x 24 x 9  
Opakowanie zbiorcze [szt]: 10  
Typ opakowania zbiorczego: pakiet  
Waga produktu z opakowaniem zbiorczym [kg]: 5.33

## DOSTĘPNE KOLORY

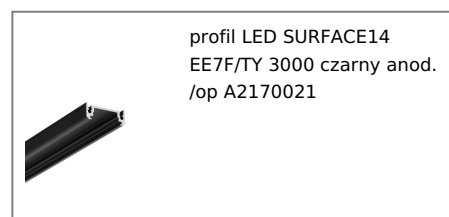
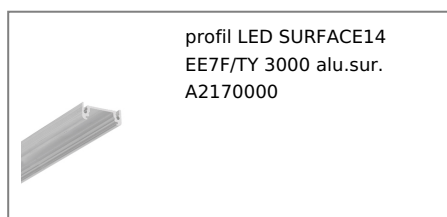
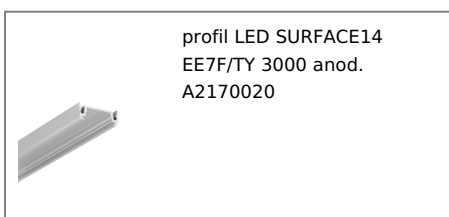

## DOSTĘPNE WARIANTY

1000 mm, 2000 mm, 3000 mm, 4050 mm

## Dopasowane elementy

---

### KLOSZE DO PROFILI LED

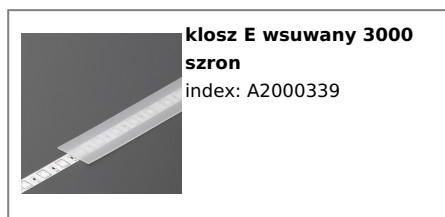

---

### ZAŚLEPKI DO PROFILI LED

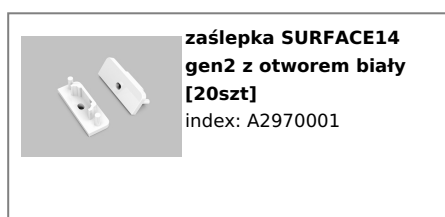

---

### ŁĄCZNIKI DO PROFILI LED



---

### UCHWYTY DO PROFILI LED



**uchwyty Y cone inox**  
**[20szt]**

index: A2130019



**uchwyty T [20szt]**

index: C6960000



**uchwyty Y inox [20szt]**

index: A2090019