





PROFIL LED GLOW12 DOWN A1C 2000 ALU.SUR.



do szpachlowania



Architektoniczne

	<ul style="list-style-type: none">• do wykańczania sufitów podwieszanych• delikatna łuna światła na ścianę• łatwe i estetyczne wykończenie krawędzi sufitu podwieszanego• do płyty gk o grubości 12,5 mm	<p> CE</p> <p> Wzory przemysłowe EU</p> <p> Wyprodukowane w Polsce</p>	 <p>Kup produkt</p>
---	---	---	--

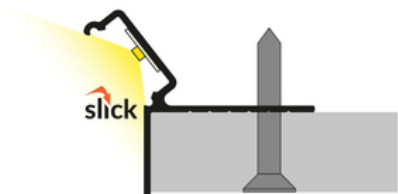
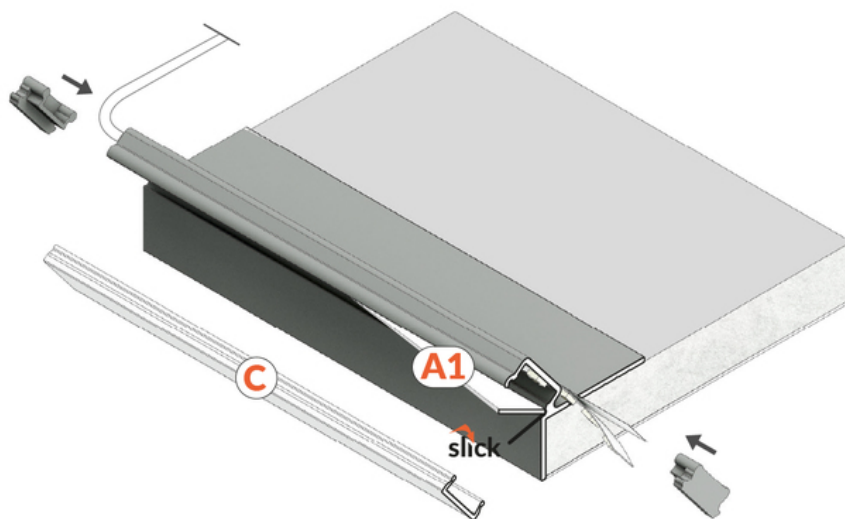
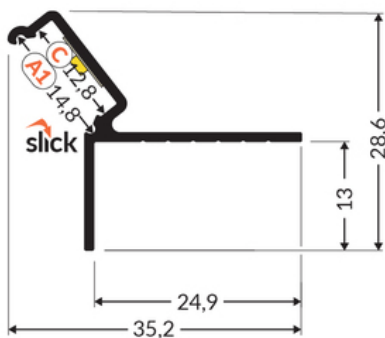



Informacje podstawowe

Indeks: K7000200
EAN: 5901597236689
Materiał: aluminium
Kolor: aluminium surowe
Długość [mm]: 2000
Szerokość [mm]: 35.2
Wysokość [mm]: 28.6
Waga [kg]: 0.382
Producent: TOPMET
Kraj pochodzenia, wytworzenia: PL

Jednostka miary: szt.
Wymiary opakowania jednostkowego [mm]: 2000 x 35,2 x 28,6
Opakowanie zbiorcze [szt]: 40
Typ opakowania zbiorczego: pakiet
Waga produktu z opakowaniem zbiorczym [kg]: 15.28

DOSTĘPNE WARIANTY

1000 mm, 2000 mm, 3000 mm, 4050 mm

Dopasowane elementy

KLOSZE DO PROFILI LED

TOPMET LIGHT KŁOSOWICZ WIŚNIEWSKI sp. z o.o.
Ostrowska 354 | 61-312 Poznań | POLAND
tel.: +48 61 872 75 00
info@topmet.pl

data wygenerowania karty pdf: 20.04.2024

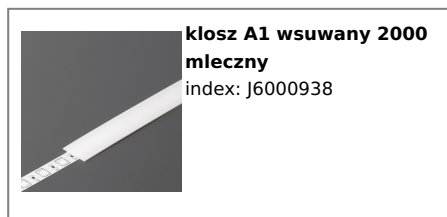

ZAŚLEPKI DO PROFILI LED

