

PROFIL LED SURFACE10.V2 BC/U 4050 ALU.SUR.



Nawierzchniowe



Meblowe



max 10 mm



- nowa generacja profili nawierzchniowych
- podstawowy i estetyczny profil meblowy
- ukryte mocowanie
- zredukowana waga
- odświeżony design



CE



Wzory przemysłowe EU



Wyprodukowane w Polsce



Kup produkt

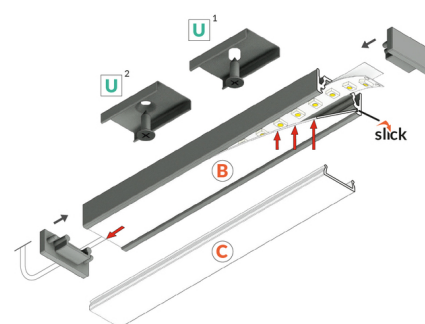
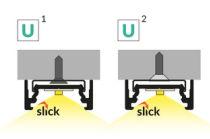
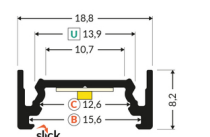
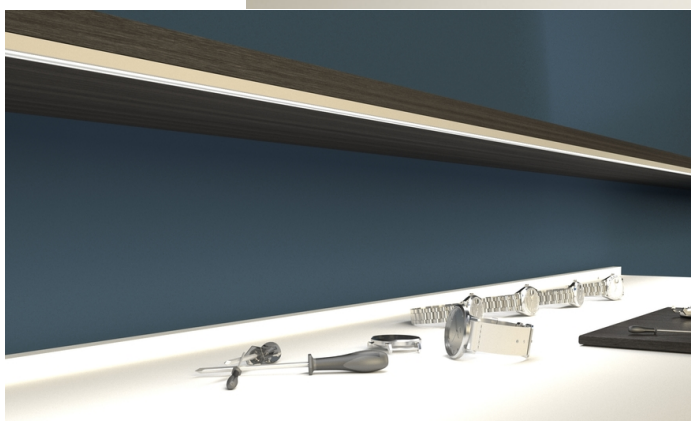
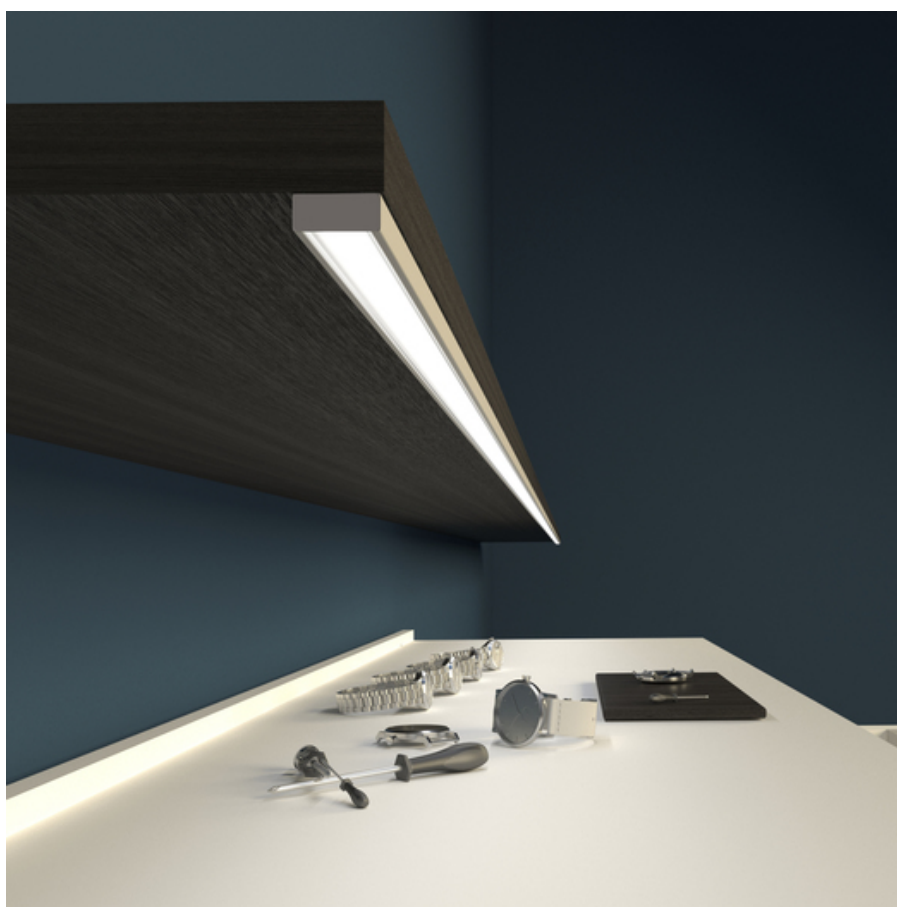

TOPMET LIGHT KŁOSOWICZ WIŚNIEWSKI sp. z o.o.

Ostrowska 354 | 61-312 Poznań | POLAND

tel.: +48 61 872 75 00

info@topmet.pl

data wygenerowania karty pdf: 20.04.2024



Informacje podstawowe

| | |
|---|--|
| Indeks: K3000400 EAN: 5901597229889 Materiał: aluminium Kolor: aluminium surowe Długość [mm]: 4050 Szerokość [mm]: 18.8 Wysokość [mm]: 8.2 Waga [kg]: 0.482 Waga opakowania [kg]: 0.012 Producent: TOPMET Kraj pochodzenia, wytworzenia: PL | Jednostka miary: szt. Wymiary opakowania jednostkowego [mm]: 4050 x 18,8 x 8,2 Opakowanie zbiorcze [szt]: 40 Typ opakowania zbiorczego: pakiet Waga produktu z opakowaniem zbiorczym [kg]: 19.28 |
|---|--|

DOSTĘPNE KOLORY

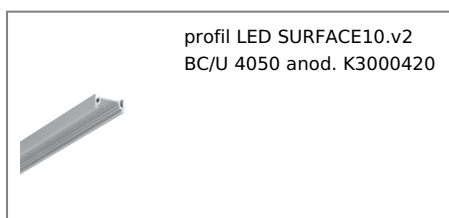

DOSTĘPNE WARIANTY

2000 mm, 4050 mm

Dopasowane elementy

KLOSZE DO PROFILI LED

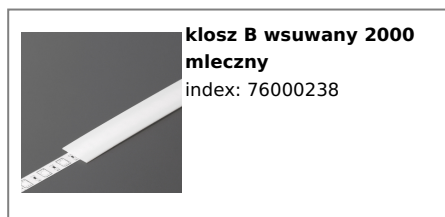

TOPMET LIGHT KŁOSOWICZ WIŚNIEWSKI sp. z o.o.

Ostrowska 354 | 61-312 Poznań | POLAND

tel.: +48 61 872 75 00

info@topmet.pl

data wygenerowania karty pdf: 20.04.2024

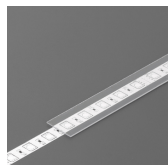

**klosz B wsuwany 2000
transparentny**
index: 76000216

ZAŚLEPKI DO PROFILI LED



**zaślepka SURFACE10.v2
szary [20szt]**
index: K3999922



**zaślepka SURFACE10.v2
srebrny [20szt]**
index: K3999940

UCHWYTY DO PROFILI LED



**uchwyt U cone inox
[20szt]**
index: 76620000



uchwyt U inox [20szt]
index: 76380000