

PROFIL LED GROOVE10.V2 A1C/U 4050 CZARNY ANOD. /OP

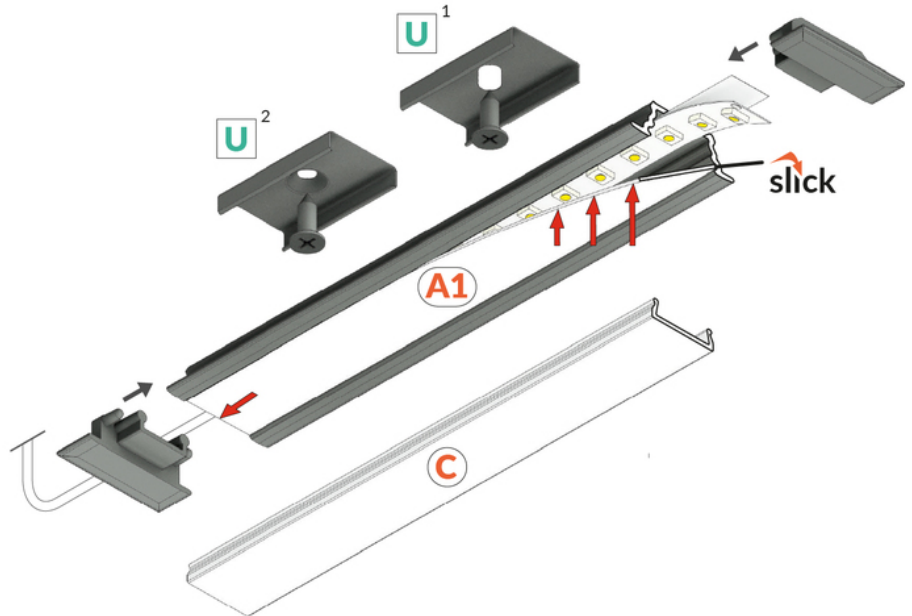

	<ul style="list-style-type: none"> • nowa generacja profili wpustowych • podstawowy i estetyczny profil meblowy • niewielka głębokość otworu montażowego 	CE Wzory przemysłowe EU Wyprodukowane w Polsce	<p>Kup produkt</p>
--	---	--	--------------------

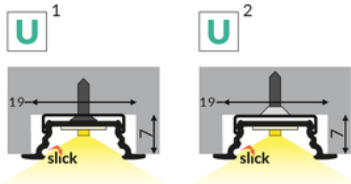

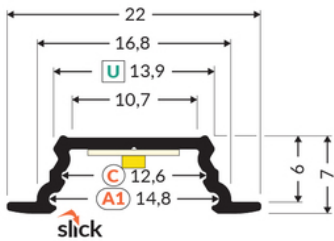

Informacje podstawowe

Indeks: K5000421 EAN: 5901597231752 Materiał: aluminium Kolor: czarny anodowany Długość [mm]: 4050 Szerokość [mm]: 22 Wysokość [mm]: 7 Waga [kg]: 0.389 Waga opakowania [kg]: 0.018 Producent: TOPMET Kraj pochodzenia, wytworzenia: PL	Jednostka miary: szt. Typ opakowania jednostkowego: folia POF Wymiary opakowania jednostkowego [mm]: 4050 x 22 x 7 Opakowanie zbiorcze [szt]: 10 Typ opakowania zbiorczego: pakiet Waga produktu z opakowaniem zbiorczym [kg]: 3.89
---	--

DOSTĘPNE KOLORY





 <p>profil LED GROOVE10.v2 A1C/U 4050 alu.sur. K5000400</p>	 <p>profil LED GROOVE10.v2 A1C/U 4050 biały mal. /op K5000401</p>	 <p>profil LED GROOVE10.v2 A1C/U 4050 anod. K5000420</p>
--	--	---

DOSTĘPNE WARIANTY

2000 mm, 4050 mm

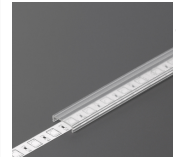
Dopasowane elementy

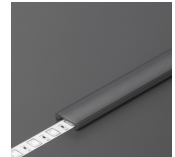
KLOSZE DO PROFILI LED

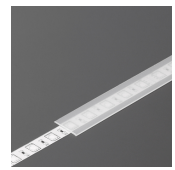
 <p>klosz C klik 4100 transparentny index: 76660000</p>	 <p>klosz C klik 4100 mleczny index: 76660038</p>	 <p>klosz C klik 4100 czarny index: 76660041</p>
 <p>klosz C klik 20m rolka mleczny /op index: 76360038S</p>	 <p>klosz A1 wsuwany 2000 mleczny index: J6000938</p>	 <p>klosz A1 wsuwany 2000 szron index: J6000939</p>

TOPMET LIGHT KŁOSOWICZ WIŚNIEWSKI sp. z o.o.

Ostrowska 354 | 61-312 Poznań | POLAND

tel.: +48 61 872 75 00

info@topmet.pl

data wygenerowania karty pdf: 23.04.2024

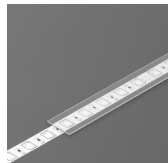

**klosz A1 wsuwany 2000
transparentny**
index: J6000916

ZAŚLEPKI DO PROFILI LED



**zaślepka GROOVE10.v2 z
otworem czarny [20szt]**
index: K5999902

UCHWYTY DO PROFILI LED



**uchwyt U cone inox
[20szt]**
index: 76620000



uchwyt U inox [20szt]
index: 76380000