





# PROFIL LED SMART-IN16 BC3/U4 2000 ANOD.



	<ul style="list-style-type: none"> <li>• głównie do zastosowania meblowego</li> <li>• możliwe zastosowanie sufitowe</li> <li>• 6 rodzajów kloszy</li> </ul>	 CE  Wzory przemysłowe EU  Wyprodukowane w Polsce	 Kup produkt
---	---	--	--



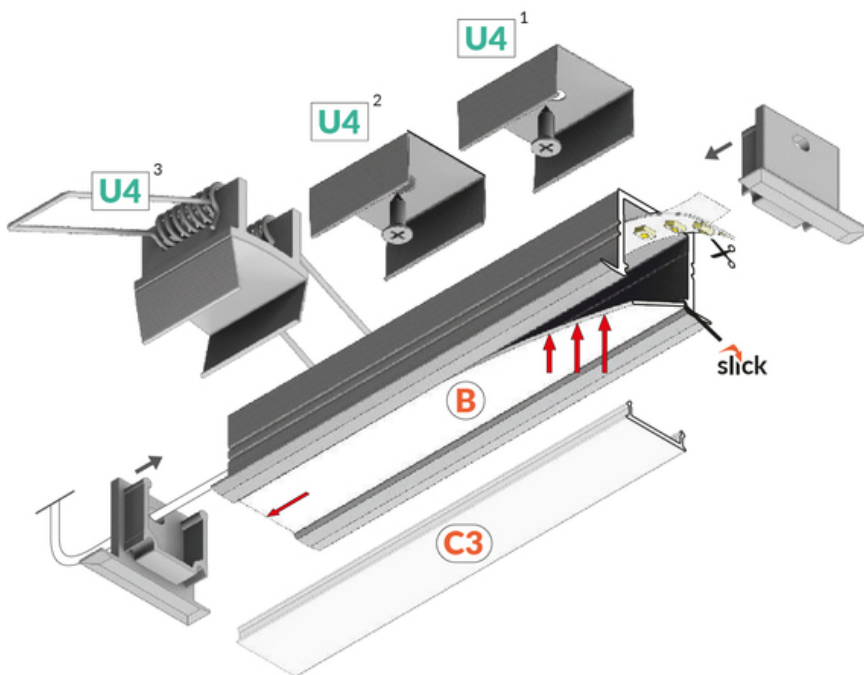
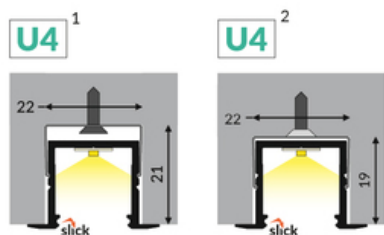
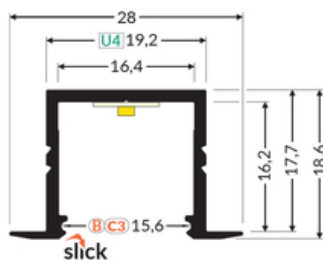

## Informacje podstawowe

Indeks: F6000220 EAN: 5901597257547 Materiał: aluminium Kolor: anodowany Długość [mm]: 2000 Szerokość [mm]: 28 Wysokość [mm]: 18.6 Waga [kg]: 0.474 Waga opakowania [kg]: 0.006 Producent: TOPMET Kraj pochodzenia, wytworzenia: PL	Jednostka miary: szt. Wymiary opakowania jednostkowego [mm]: 2000 x 28 x 18,6 Opakowanie zbiorcze [szt]: 40 Typ opakowania zbiorczego: pakiet Waga produktu z opakowaniem zbiorczym [kg]: 18.96
---	---

## DOSTĘPNE KOLORY

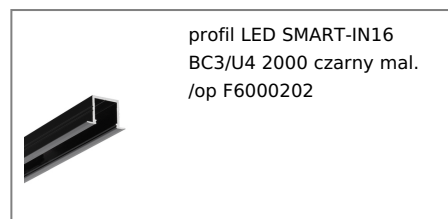
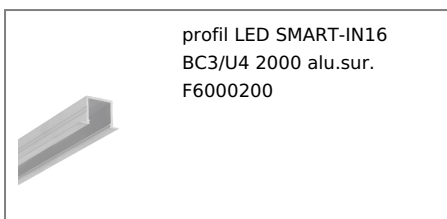

## DOSTĘPNE WARIANTY

1000 mm, 2000 mm, 3000 mm, 4050 mm

## Dopasowane elementy

### KLOSZE DO PROFILI LED



### ZAŚLEPKI DO PROFILI LED



### UCHWYTY DO PROFILI LED

TOPMET LIGHT KŁOSOWICZ WIŚNIEWSKI sp. z o.o.

Ostrowska 354 | 61-312 Poznań | POLAND

tel.: +48 61 872 75 00

info@topmet.pl

data wygenerowania karty pdf: 19.04.2024



**uchwyt U4 cone inox**  
**[20szt]**

index: F1980019



**uchwyt U4 inox [20szt]**

index: F1970019



**uchwyt U4 sprężyna inox**  
**[2szt]**

index: F6009819S