

# PROFIL LED LINEA-IN20 EE7F/U7 2000 ANOD.

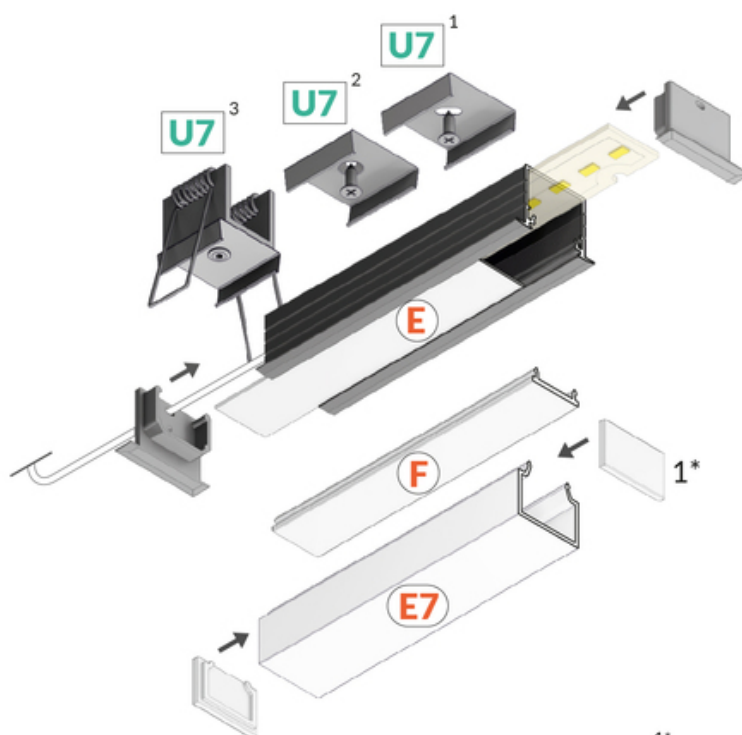

	<ul style="list-style-type: none"><li>• ciągła linia światła (przy użyciu taśm 120 P/m oraz klosza mlecznego)</li><li>• świecące połączenia kątowe</li><li>• ponad 20 akcesoriów</li></ul>	<p> CE</p> <p> Wzory przemysłowe EU</p> <p> Wyprodukowane w Polsce</p>	 <p>Kup produkt</p>
---	--	---	--

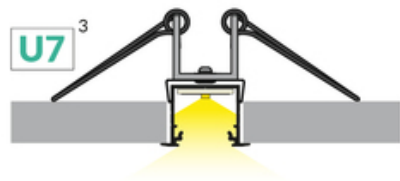
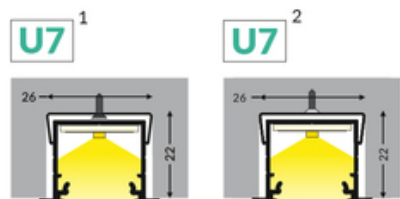
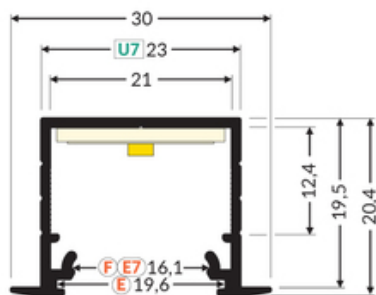

1\*  
end cap E7  
zaślepka E7

TOPMET LIGHT KŁOSOWICZ WIŚNIEWSKI sp. z o.o.

Ostrowska 354 | 61-312 Poznań | POLAND

tel.: +48 61 872 75 00

info@topmet.pl

data wygenerowania karty pdf: 19.04.2024

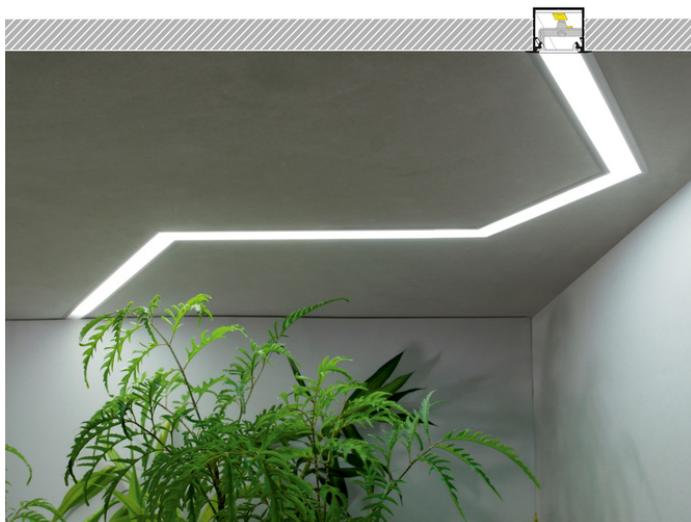

## Informacje podstawowe

Indeks: E4020020  
EAN: 5901597237273  
Materiał: aluminium  
Kolor: anodowany  
Długość [mm]: 2000  
Szerokość [mm]: 30  
Wysokość [mm]: 20.4  
Waga [kg]: 0.436  
Producent: TOPMET  
Kraj pochodzenia, wytworzenia: PL

Jednostka miary: szt.  
Wymiary opakowania jednostkowego [mm]: 2000 x 30 x 20,4  
Opakowanie zbiorcze [szt]: 20  
Typ opakowania zbiorczego: pakiet  
Waga produktu z opakowaniem zbiorczym [kg]: 8.72

## DOSTĘPNE KOLORY

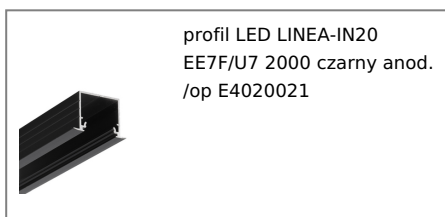

## DOSTĘPNE WARIANTY

1000 mm, 2000 mm, 3000 mm, 4050 mm

## Dopasowane elementy

TOPMET LIGHT KŁOSOWICZ WIŚNIEWSKI sp. z o.o.  
Ostrowska 354 | 61-312 Poznań | POLAND  
tel.: +48 61 872 75 00  
info@topmet.pl

data wygenerowania karty pdf: 19.04.2024

## KLOSZE DO PROFILI LED

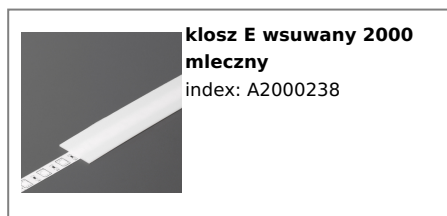

## ZAŚLEPKI DO PROFILI LED

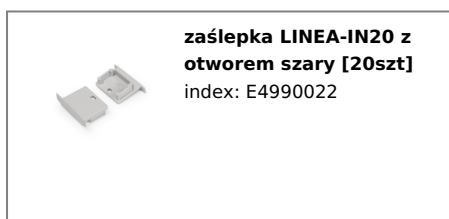

## ŁĄCZNIKI DO PROFILI LED



**łącznik LINEA-IN20 60st  
anod. /op**  
index: E4890020s



**łącznik LINEA-IN20 90st  
anod. /op**  
index: E4900020s



**łącznik LINEA-IN20 90st  
gięty anod. /op**  
index: E4910020s



**łącznik LINEA-IN20 120st  
anod. /op**  
index: E4920020s



**łącznik LINEA-IN20 135st  
anod. /op**  
index: E4930020s



**łącznik LINEA-IN20 180st  
/op**  
index: E4940000s



**łącznik LINEA-IN20 270st  
gięty anod. /op**  
index: E4950020s

---

## POZOSTAŁE



**docisk LED LINEA20  
biały mal. [20szt]**  
index: C6940001

matching image or type unknown

**docisk LED LINEA20-1  
biały [20szt]**  
index: C6930001