

PROFIL LED CORNER10 BC/UX 3000 ANOD.



max 10 mm



Katowe



Meblowe

	<ul style="list-style-type: none"> dwa kąty świecenia: 30° i 60° ukryte mocowanie szeroki wybór akcesoriów, 7 rodzajów kloszy 	<ul style="list-style-type: none"> Wzory przemysłowe EU CE Wyprodukowane w Polsce 	<p>Kup produkt</p>
--	--	---	--------------------

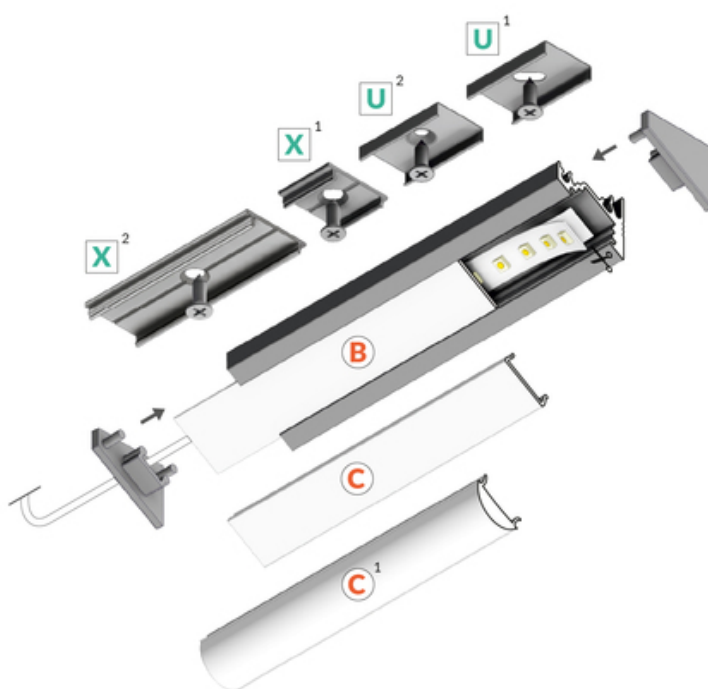
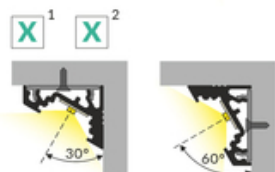
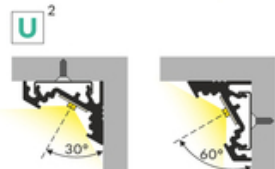
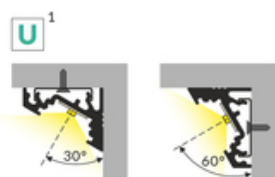
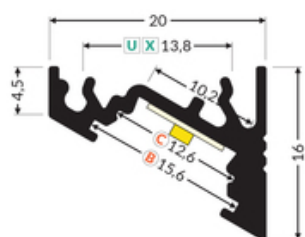

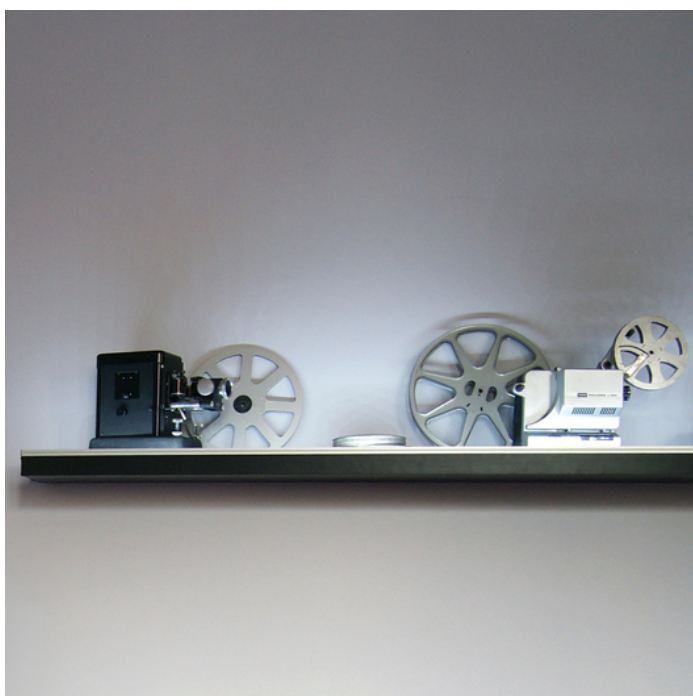

Informacje podstawowe

Indeks: 83180020 EAN: 5901597239215 Materiał: aluminium Kolor: anodowany Długość [mm]: 3000 Szerokość [mm]: 20 Wysokość [mm]: 16 Waga [kg]: 0.582 Producent: TOPMET Kraj pochodzenia, wytworzenia: PL	Jednostka miary: szt. Wymiary opakowania jednostkowego [mm]: 3000 x 20 x 16 Opakowanie zbiorcze [szt]: 40 Typ opakowania zbiorczego: pakiet Waga produktu z opakowaniem zbiorczym [kg]: 23.28
--	---

DOSTĘPNE KOLORY



DOSTĘPNE WARIANTY

1000 mm, 2000 mm, 3000 mm, 4050 mm

Dopasowane elementy

KLOSZE DO PROFILI LED



ZAŚLEPKI DO PROFILI LED



(EOL) zaślepka CORNER10 szary [20szt]
index: 83150022



(EOL) zaślepka CORNER10 srebro [20szt]
index: 83150040



zaślepka CORNER10 gen2 szary [20szt]
index: 83990022



zaślepka CORNER10 gen2 srebro [20szt]
index: 83990040



zaślepka CORNER10 gen2 z otworem szary [20szt]
index: 83980022



zaślepka CORNER10 gen2 z otworem srebro [20szt]
index: 83980040

ŁĄCZNIKI DO PROFILI LED



łącznik CORNER10 90st anod. /op
index: 83110020



łącznik X 180st [1szt]
index: 76350000

UCHWYTY DO PROFILI LED



uchwyt U cone inox [20szt]
index: 76620000

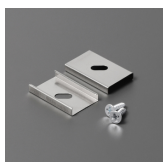

uchwyt U inox [20szt]
index: 76380000

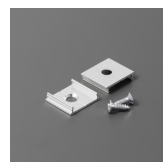

uchwyt X [20szt]
index: 76260000