

PROFIL LED OMNI10 AC2 4050 ANOD.



Architektoniczne



max 10 mm



do szpachlowania



- oświetlenie dekoracyjne, niewidoczny profil i klosz
- profil do wykończenia płyty kartonowo-gipsowej o minimalnej grubości 12,5 mm
- wiele możliwych aranżacji
- gniazdo Slick



Wzory przemysłowe EU



CE



Wyprodukowane w Polsce



Kup produkt

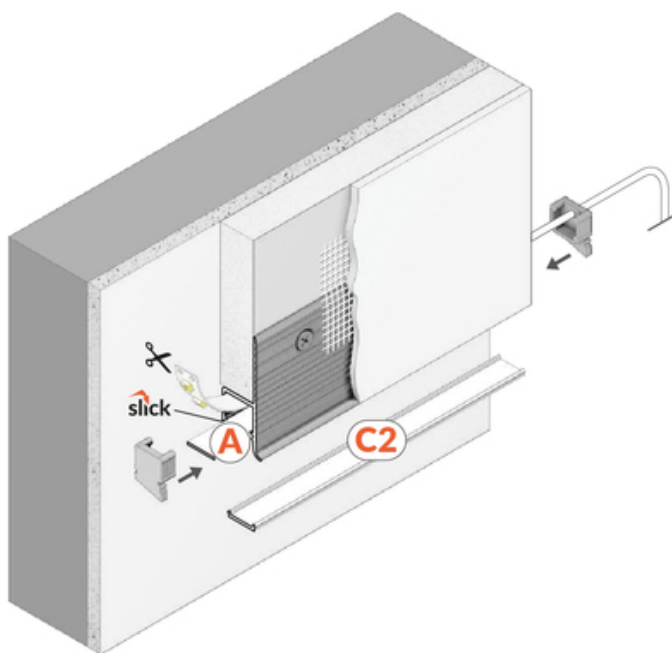
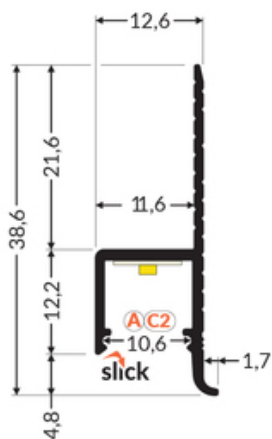

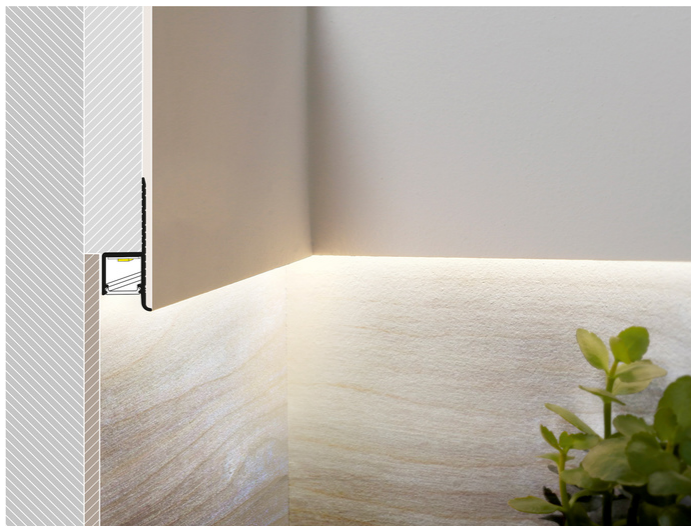

Informacje podstawowe

Indeks: H4000420 EAN: 5901597284024 Materiał: aluminium Kolor: anodowany Długość [mm]: 4050 Szerokość [mm]: 14.3 Wysokość [mm]: 38.6 Waga [kg]: 0.745 Producent: TOPMET Kraj pochodzenia, wytworzenia: PL	Jednostka miary: szt. Wymiary opakowania jednostkowego [mm]: 4050 x 14,3 x 38,6 Opakowanie zbiorcze [szt]: 40 Typ opakowania zbiorczego: pakiet Waga produktu z opakowaniem zbiorczym [kg]: 29.8
--	--

DOSTĘPNE KOLORY

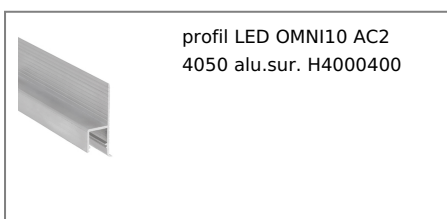

DOSTĘPNE WARIANTY

1000 mm, 2000 mm, 3000 mm, 4050 mm

Dopasowane elementy

KLOSZE DO PROFILI LED

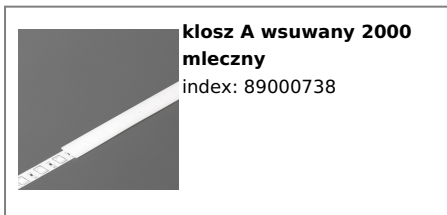

ZAŚLEPKI DO PROFILI LED



zaślepka OMNI10 szary
[20szt]
index: H4999922