





PROFIL LED PEN8 I 2000 ANOD.



	<ul style="list-style-type: none">• profil dekoracyjno-oświetleniowy, np. do szklanych gablot• możliwość mocowania pomiędzy ściankami	<ul style="list-style-type: none"> Wzory przemysłowe EU CE Wyprodukowane w Polsce	 Kup produkt
---	--	--	--



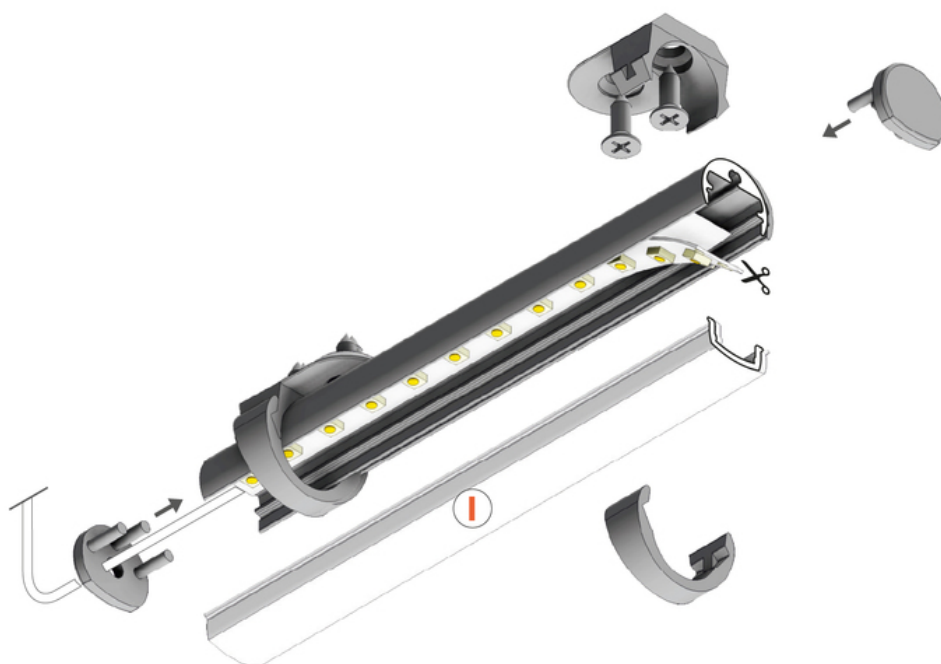
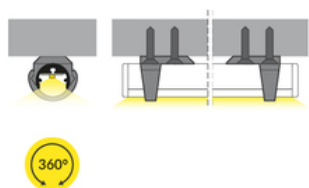
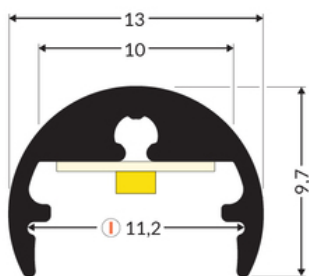

Informacje podstawowe

Indeks: 86030020
EAN: 5901597201335
Materiał: aluminium
Kolor: anodowany
Długość [mm]: 2000
Szerokość [mm]: 13
Wysokość [mm]: 9.7
Waga [kg]: 0.22
Producent: TOPMET
Kraj pochodzenia, wytworzenia: PL

Jednostka miary: szt.
Wymiary opakowania jednostkowego [mm]: 2000 x 13 x 9,7
Opakowanie zbiorcze [szt]: 40
Typ opakowania zbiorczego: pakiet
Waga produktu z opakowaniem zbiorczym [kg]: 8.8

DOSTĘPNE WARIANTY

1000 mm, 2000 mm, 3000 mm, 4050 mm

Dopasowane elementy

KLOSZE DO PROFILI LED



ZAŚLEPKI DO PROFILI LED



zaślepka PEN8 z otworem srebro [20szt]
index: 86470040



zaślepka PEN8 z otworem szary [20szt]
index: 86470022



zaślepka PEN8 srebro [20szt]
index: 86490040



zaślepka PEN8 szary [20szt]
index: 86490022

UCHWYTY DO PROFILI LED



uchwyt PEN8 prosty ocynk [2szt]
index: 86370030



uchwyt PEN8 płaski szary [20szt]
index: 86070022



(EOL) uchwyt PEN8 rozporowy chrom
index: 86290003



uchwyt PEN8 ring sur. [2szt]
index: 86440000



(EOL) uchwyt PEN8 przegubowy z podsufitką chrom
index: 86080003



(EOL) uchwyt PEN8 przegubowy z gwintem chrom
index: 86090003



(EOL) uchwyt PEN8 końcowy chrom
index: 86160003



(EOL) uchwyt PEN8 przegubowy 100 z podsufitką chrom
index: 86300003



(EOL) uchwyt PEN8 przegubowy 200 z podsufitką chrom
index: 86100003



(EOL) uchwyt PEN8 przegubowy 300 z podsufitką chrom
index: 86120003



(EOL) uchwyt PEN8 przegubowy 100 z gwintem chrom
index: 86310003



(EOL) uchwyt PEN8 przegubowy 200 z gwintem chrom
index: 86110003



**(EOL) uchwyt PEN8
przegubowy 300 z
gwintem chrom**
index: 86130003



**(EOL) uchwyt PEN8
podwójny 100 z
podsufitkami chrom**
index: 86320003



**(EOL) uchwyt PEN8
podwójny 200 z
podsufitkami chrom**
index: 86170003



**(EOL) uchwyt PEN8
podwójny 300 z
podsufitkami chrom**
index: 86190003



**(EOL) uchwyt PEN8
podwójny 100 z gwintem
chrom**
index: 86330003



**(EOL) uchwyt PEN8
podwójny 200 z gwintem
chrom**
index: 86180003