





PROFIL LED BACK10 A/UX 2000 ANOD.



	<ul style="list-style-type: none">• oświetlenie dekoracyjne• konstrukcja w kształcie litery "T" pozwala na skierowanie strumienia świetlnego w dwóch kierunkach (góra/dół, lewo/prawo)• mocowanie za pomocą dedykowanych uchwytów (do ściany) lub bezpośrednio przy pomocy wkrętów (do mebla)• opcjonalne użycie klosza A	 <p>Wzory przemysłowe EU</p>  <p>CE</p>  <p>Wyprodukowane w Polsce</p>	 <p>Kup produkt</p>
---	--	---	--



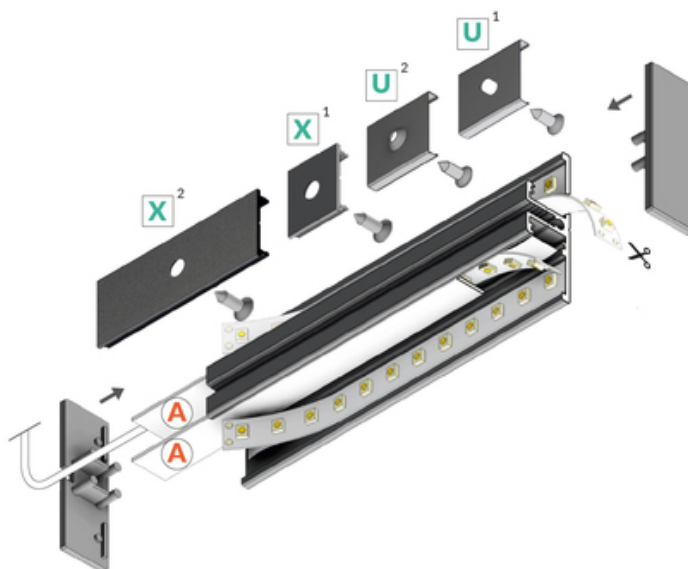
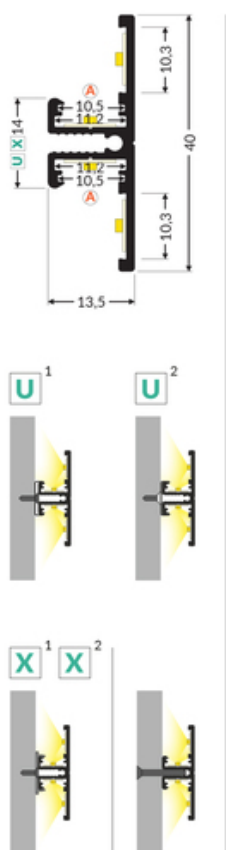
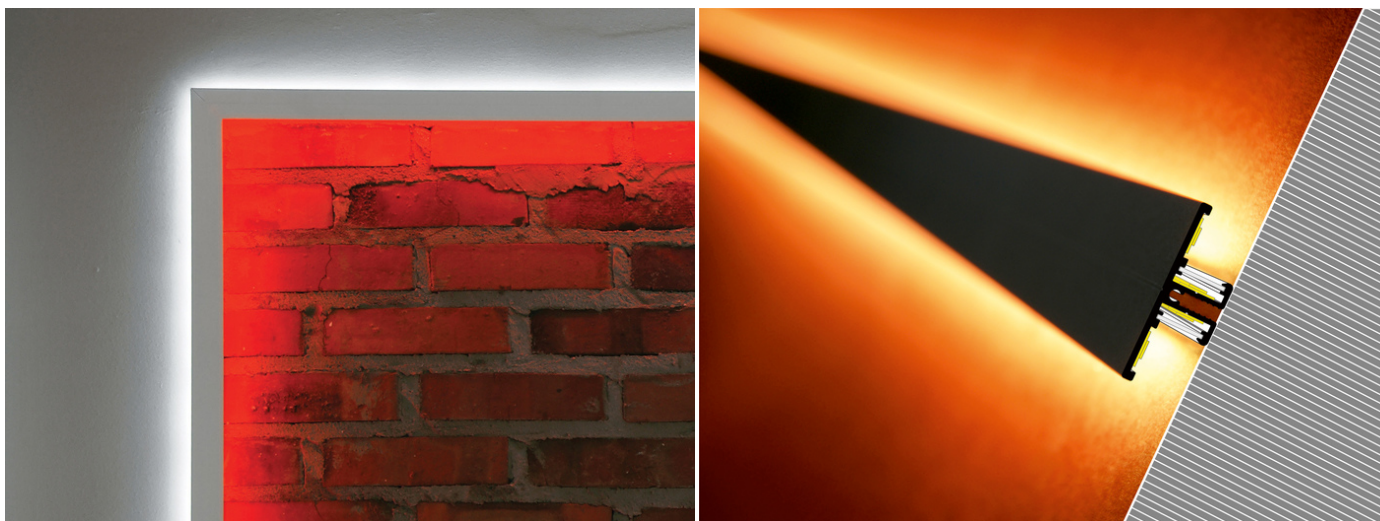

Informacje podstawowe

Indeks: 90030020 EAN: 5901597205333 Materiał: aluminium Kolor: anodowany Długość [mm]: 2000 Szerokość [mm]: 13.5 Wysokość [mm]: 40 Waga [kg]: 0.57 Producent: TOPMET Kraj pochodzenia, wytworzenia: PL	Jednostka miary: szt. Wymiary opakowania jednostkowego [mm]: 2000 x 13,5 x 40 Opakowanie zbiorcze [szt]: 20 Typ opakowania zbiorczego: pakiet Waga produktu z opakowaniem zbiorczym [kg]: 11.4
---	--

DOSTĘPNE KOLORY

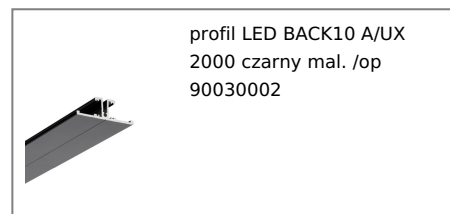
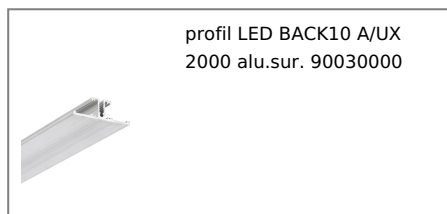

DOSTĘPNE WARIANTY

1000 mm, 2000 mm, 3000 mm, 4050 mm

Dopasowane elementy

TOPMET LIGHT KŁOSOWICZ WIŚNIEWSKI sp. z o.o.

Ostrowska 354 | 61-312 Poznań | POLAND

tel.: +48 61 872 75 00

info@topmet.pl

data wygenerowania karty pdf: 25.04.2024

KŁOSZE DO PROFILI LED



ZAŚLEPKI DO PROFILI LED

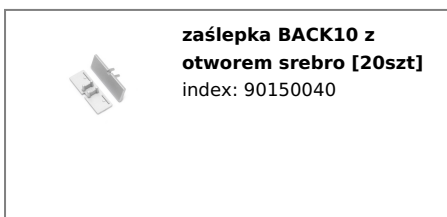

ŁĄCZNIKI DO PROFILI LED



UCHWYTY DO PROFILI LED

