





PROFIL LED UNI-TILE12 180ST C PLUS 1000 ANOD.



Do płytek

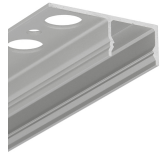

Architektoniczne

| | | |
|---|---|--|
|  |  <p>Wzory przemysłowe EU</p>  <p>CE</p>  <p>Wyprodukowane w Polsce</p> |  <p>Kup produkt</p> |
|---|---|--|

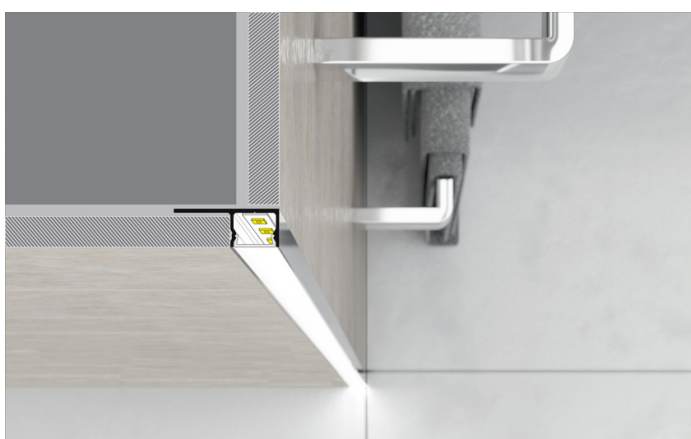
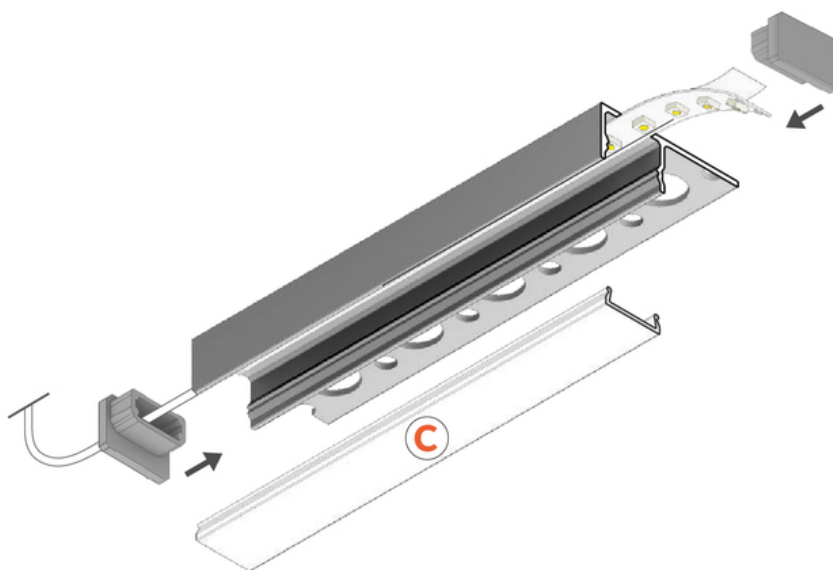
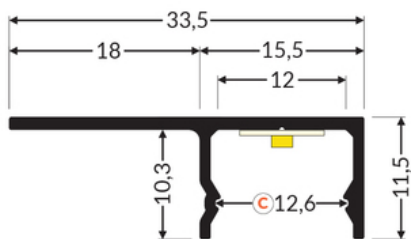

Informacje podstawowe

TOPMET LIGHT KŁOSOWICZ WIŚNIEWSKI sp. z o.o.

Ostrowska 354 | 61-312 Poznań | POLAND

tel.: +48 61 872 75 00

info@topmet.pl

data wygenerowania karty pdf: 23.04.2024

| | |
|--|--|
| Indeks: G2000520 EAN: 5901597260882 Materiał: aluminium Kolor: anodowany Długość [mm]: 1000 Szerokość [mm]: 33.5 Wysokość [mm]: 11.5 Waga [kg]: 0.218 Producent: TOPMET Kraj pochodzenia, wytworzenia: PL | Jednostka miary: szt. Wymiary opakowania jednostkowego [mm]: 1000 x 33,5 x 11,5 Opakowanie zbiorcze [szt]: 40 Typ opakowania zbiorczego: pakiet Waga produktu z opakowaniem zbiorczym [kg]: 8.72 |
|--|--|

DOSTĘPNE WARIANTY

1000 mm, 2000 mm, 3000 mm, 4050 mm

Dopasowane elementy

KŁOSZE DO PROFILI LED



ZAŚLEPKI DO PROFILI LED

