





# PROFIL LED UNI-TILE12 180ST C PLUS 3000 ANOD.



Do płytek

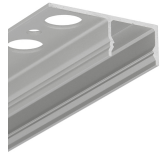

Architektoniczne

	 CE  Wzory przemysłowe EU  Wyprodukowane w Polsce	  Kup produkt
---	--	--

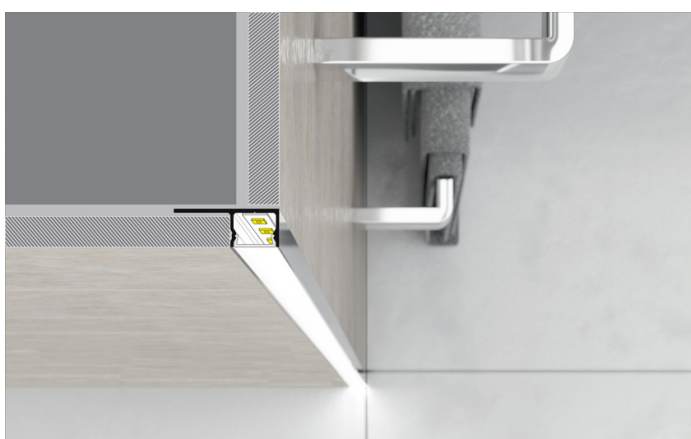
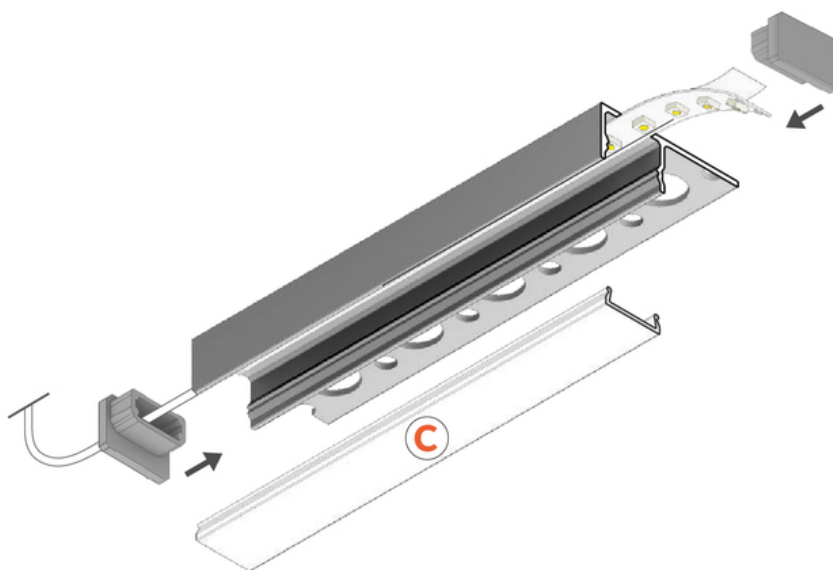
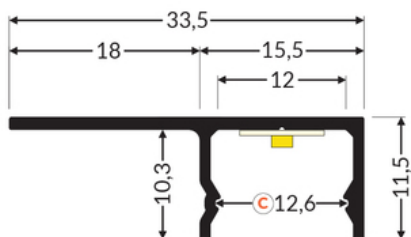

## Informacje podstawowe

TOPMET LIGHT KŁOSOWICZ WIŚNIEWSKI sp. z o.o.

Ostrowska 354 | 61-312 Poznań | POLAND

tel.: +48 61 872 75 00

info@topmet.pl

data wygenerowania karty pdf: 26.04.2024

Indeks: G2000820 EAN: 5901597260912 Materiał: aluminium Kolor: anodowany Długość [mm]: 3000 Szerokość [mm]: 33.5 Wysokość [mm]: 11.5 Waga [kg]: 0.654 Producent: TOPMET Kraj pochodzenia, wytworzenia: PL	Jednostka miary: szt. Wymiary opakowania jednostkowego [mm]: 3000 x 33,5 x 11,5 Opakowanie zbiorcze [szt]: 40 Typ opakowania zbiorczego: pakiet Waga produktu z opakowaniem zbiorczym [kg]: 26.16
--	---

## DOSTĘPNE WARIANTY

1000 mm, 2000 mm, 3000 mm, 4050 mm

## Dopasowane elementy

### KŁOSZE DO PROFILI LED



### ZAŚLEPKI DO PROFILI LED

